

SIMATIC Panels

Operator panels to suit all demands

Brochure · April 2009



SIMATIC HMI

Answers for industry.

SIEMENS

Totally Integrated Automation

Rely on new productivity standards
for sustained competitive advantages

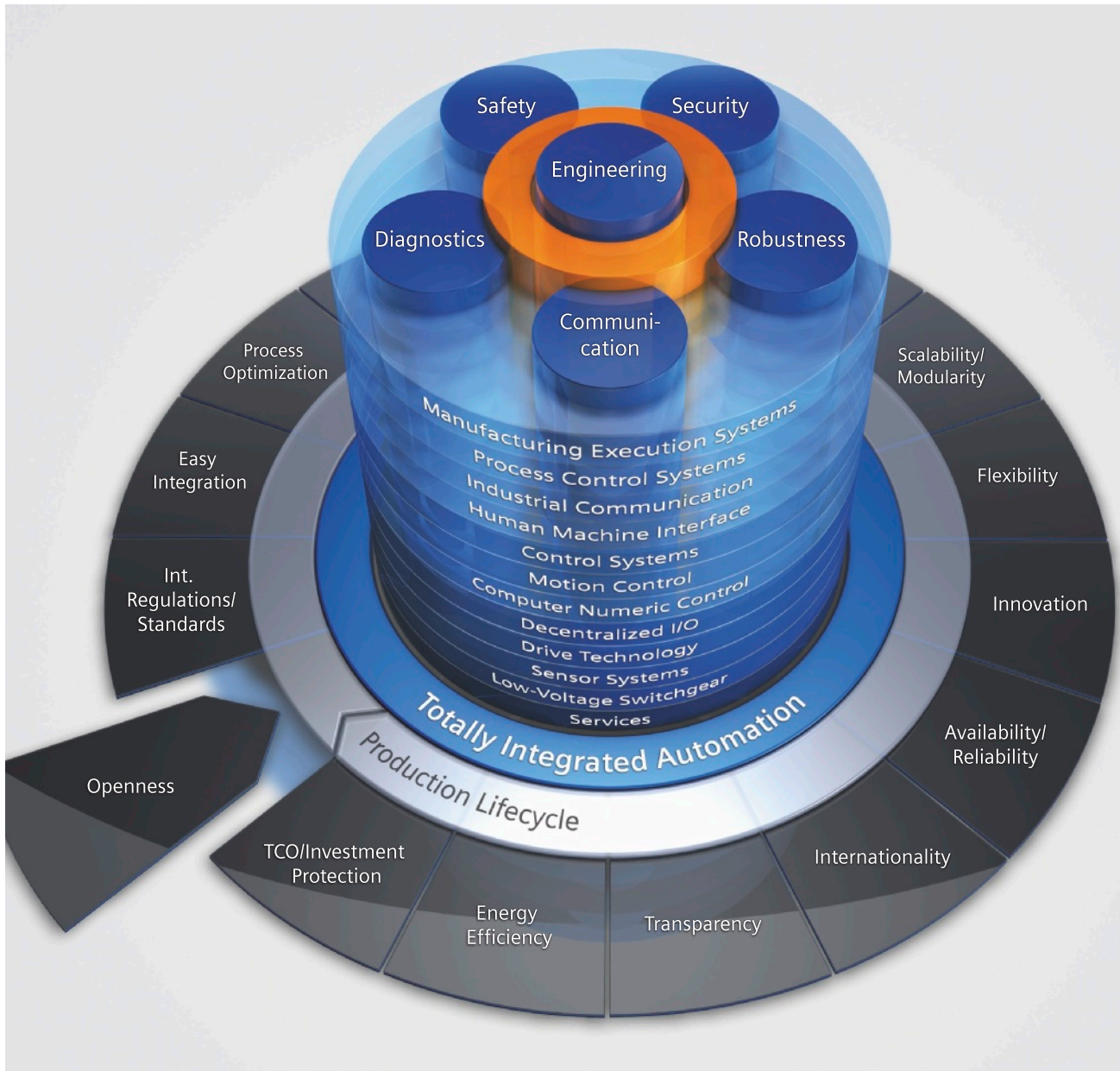

To be able to respond to the increasing international competitive pressure, it is more important than ever to consistently make full use of the potential for optimization – over the complete lifecycle of a machine or plant.

Optimized processes reduce the total cost of ownership, shorten the time to market, and improve quality. This perfect balance between quality, time, and costs is now, more than ever, the decisive success factor in industry.

Contents

Totally Integrated Automation is optimally aligned to all requirements and open for international standards and third-party systems. With its six characteristic system features (engineering, communications, diagnosis, safety, security, and robustness), Totally Integrated Automation supports the complete lifecycle of a machine or plant. The complete system architecture offers holistic solutions for every automation segment on the basis of a comprehensive range of products.

SIMATIC: more efficient and systematic automation

SIMATIC, a core component of Totally Integrated Automation, includes a variety of standardized, flexible, and scalable products – such as SIMATIC Panels presented in this brochure.

SIMATIC is currently considered to be the global number one in automation. One of the decisive reasons for this is that SIMATIC exhibits the six system features of Totally Integrated Automation:

- Engineering
- Communication
- Diagnosis
- Safety
- Security
- Robustness

In addition, SIMATIC features two additional system features:

- Technology
- High availability

You can find more about the system features and the resulting advantages in the following chapter "System features".

SIMATIC Panels	
System features	4
Operator panels to suit all demands	6
WinCC flexible	
Maximum configuration efficiency for all applications	8
SIMATIC Panels – Product range	
SIMATIC Push Button Panels	10
SIMATIC Micro Panels with the SIMATIC S7-200	11
SIMATIC Mobile Panels	12
SIMATIC Basic Panels	15
SIMATIC Panels – 70 series	16
SIMATIC Panels – 170 series	17
SIMATIC Panels – 270 series	18
SIMATIC Multi Panels – 170/270/370 series	19
SIMATIC Thin Clients	21
SIMATIC Panels with stainless steel front	22
Fully protected HMI devices	23
Customer-specific solutions	24
Accessories, starter and promotion packages	
Accessories for SIMATIC Operator Panels	25
SIMATIC Panels starter packages	26
The new SIMATIC HMI promotion packages	27

System features

Engineering



Maximum engineering efficiency – in all phases of the lifecycle of the machine and plant

With SIMATIC you rely on an integrated engineering environment. Efficient software supports you over the complete lifecycle of your machine or plant – from the planning and design stages through configuring and programming as far as commissioning, operation and upgrading. With its integration capability and harmonized interfaces, SIMATIC software supports a high degree of data consistency – throughout the entire engineering process.

Communications



Maximum data transparency on all automation levels – based on proven standards

SIMATIC creates the foundations for unlimited integration in communication – and thus for maximum transparency on all levels, from the field and control level to the operations management level all the way up to the corporate management level. SIMATIC relies on international, cross-vendor standards which can be combined flexibly: PROFIBUS, the global No. 1 fieldbus, and PROFINET, the leading Industrial Ethernet standard.

Diagnosis



Minimization of downtimes – through efficient diagnosis concepts

All SIMATIC products feature integrated diagnostic functions with which a fault can be identified and eliminated to provide increased system availability. Even with larger plants, the Maintenance Station provides you with a uniform view of the maintenance-relevant information of all automation components.

Safety



Protection of personnel and machines – within the framework of an integrated complete system

SIMATIC Safety Integrated offers TÜV-certified products, which facilitate compliance with relevant standards: IEC 62061 up to SIL 3, EN ISO 13849-1 up to PL e, as well as EN 954-1. Due to the integration of safety technology in standard technology, only one controller, one I/O, one engineering, and one bus system are required. Thus the system advantages and comprehensive functionality of SIMATIC are also available for fail-safe applications.

Data security in the networked world – through harmonized, scalable security systems

With SIMATIC you can use all the advantages that result as the worlds of automation and office grow together more and more: Seamless exchange of data across all levels (Collaborative Manufacturing), or access to production data via the Internet from any location. In order to meet the resulting increased security requirements, SIMATIC offers you IT Security for the protection of production and data, e.g. by means of firewall functions, access protection, encryption, and Virtual Private Networks.



Security

Maximum industrial suitability – through increased robustness

Each standard product from the SIMATIC range is characterized by the highest quality and robustness and is perfect for use in industrial environments. Specific system tests ensure the planned and required quality. SIMATIC components meet all relevant international standards and are certified accordingly. Temperature and shock resistance are defined in the SIMATIC quality guidelines, as are vibration resistance or electromagnetic compatibility. For demanding to extreme rated conditions, special versions such as SIPLUS extreme or special versions of SIMATIC ET200 are available. These include an increased degree of protection, extended temperature ranges, and exceptional environmental stress.



Robustness

More possibilities, less complexity – through integrated technology functionality

Counting and measuring, cam control, closed-loop control, or motion control: You can integrate technological tasks in many different combinations and with various degrees of complexity without a system changeover into the world of SIMATIC – easily, conveniently, consistently. Parameter assignment and programming are implemented in the familiar STEP 7 environment.



Technology

Maximum availability – with integrated high availability concepts

Siemens offers a comprehensive high availability concept to ensure high availability for the entire plant: from the field level to the control level all the way up to the management level. For example, field-tested controllers ensure high availability through bumpless switching with automatic event synchronization.



High availability

SIMATIC Panels

Operator panels to suit all demands

SIMATIC Panels have been proving their value in many different applications in all industrial sectors for many years now. Their innovative power is undiminished here.

With SIMATIC Panels, you have absolute control over even the most complex processes, which increases the availability and productivity of your plant. SIMATIC Panels provide the interface between man and machine and offer maximum transparency.

The product range includes versions for all industrial applications: from a simple operator keypad to mobile and stationary panels and all the way to the flexible Multi Panel. Devices with PROFINET connection are used for solutions that utilize the Industrial Ethernet standard for automation. Devices with complete IP65 protection can be located on supporting arms or stands – wherever is best for the operator.

Rugged for use at the machine level

With IP65/NEMA 4 degree of protection on the front side, high EMC and extreme vibration resistance, the SIMATIC Operator Panels are ideally suited for use at the machine level in harsh industrial environments. Approvals for many different sectors/applications are the proof.

(www.siemens.com/simatic/zertificates)

Selection of possible operating modes

SIMATIC Panels are available as Key or Touch panels. Some even offer both at the same time.

Everything at a glance on brilliant displays

All SIMATIC Panels have large, bright and high-contrast displays for optimal operator control and monitoring. Whether text-based or pixel-graphics, color or monochrome, with display sizes of 3 to 19" – now also in 4" widescreen format – the long service life of the backlighting convinces in every case.

Diverse connection options

As standard, SIMATIC Panels communicate over PROFIBUS. PROFINET/Ethernet are gaining importance. Most SIMATIC Panels are already prepared for this. Other devices, such as printers, can be connected through additional interfaces such as USB.

The software: integrated and scalable

SIMATIC Panels are configured with an integrated software tool: SIMATIC WinCC flexible. WinCC flexible is scalable to match the different performance levels of the panels.

SIMATIC Operator Panel series							
	Push Button Panels ⁵⁾	TD ⁶⁾	Micro Panels		Mobile Panels		Basic Panels ⁵⁾
			70 series	170 series ⁵⁾	170 series	270 series	
Mobile					●	●	
Stationary	●	●	●	●			●
Operation							
Touch				●		● ¹⁾	● ¹⁾
Key	●	●	●				
Touch and Key					●	●	●
Display							
TFT						●	●
STN		●	●	●	●		
Interfaces							
PPI	●	●	●	●	●	● ³⁾	
PROFIBUS	●				● ¹⁾	● ³⁾	● ¹⁾
PROFINET/Ethernet	●				● ¹⁾	● ⁴⁾	● ¹⁾
USB						●	
HMI functionality							
Signaling system	● ²⁾	●	●	●	●	●	●
Recipes					●	●	●
Archive						●	
Visual Basic scripts						●	
Software options					●	●	

If you are looking for exactly the right operator panel for your application, we recommend you use the [SIMATIC HMI selection guide](#).

You can find it at: www.siemens.com/simatic-hmi with the most up-to-date product range.

- Feature always available
- Feature available in the devices of the upper performance range of the series

Perfectly suited for worldwide use

Approvals for the most important export countries are available. In addition to the standard version of WinCC flexible with five configuration languages (German, English, French, Spanish, and Italian), there is also a version for Asia with four Asian languages. Multilingual configuration is supported by automated text translation and text export and text import functions. Up to 32 languages can be administered in one project.

Open for a wide variety of automation systems

Different interfacing options for SIMATIC S7, drivers for non-Siemens controllers, and vendor-independent communication over OPC ensure the correct connection for many different automation solutions.

Embedded Automation on the basis of SIMATIC Multi Panels

Embedded Automation stands for control solutions specially tailored to embedded operating systems and which utilize rugged diskless devices without fans as hardware. SIMATIC Multi Panels support Embedded Automation in a special way: With an integral display, they allow HMI functions as well as controller functions in a single device.

SIMATIC Basic Panels

For small machines or simple applications: Basic Panels offer basic functionality at an attractive price.

Highlights of SIMATIC Panels

- Integrated configuration, data management, and communication
- Designed for harsh industrial environments
 - Rugged and compact
 - Safe and ergonomic operation by means of keypads or touch screens
 - Brilliant displays for best readability
- Open and easy to extend
 - Cross-manufacturer OPC communication (OPC server) for Multi Panels
 - Controllers from the most diverse manufacturers can be connected
 - TCP/IP via PROFINET/Ethernet
 - Innovative HMI concepts: Traceability/easy validation, service and diagnostics via the Internet
 - Worldwide application with extensive language support, including Asian languages
- Proven Siemens quality

	Panels			Multi Panels			
	70 series ⁵⁾	170 series ⁵⁾	270 series ⁵⁾	170 series ⁵⁾	270 series ⁵⁾	370 series ⁵⁾	
	●	●	●	●	●	●	Mobile
							Stationary
							Operation
		● ¹⁾	● ¹⁾	●	●	● ¹⁾	Touch
	●	● ¹⁾	● ¹⁾			● ¹⁾	Key
		●					Touch and Key
							Display
				●	●	●	TFT
	●	●	●				STN
							Interfaces
	●	●	●	●	●	●	PPI
	●	●		●	●	●	PROFIBUS
		●		●	●	●	PROFINET/Ethernet
	●	●		●	●	●	USB
							HMI functionality
	●	●	●	●	●	●	Signaling system
	●	●		●	●	●	Recipes
					●	●	Archive
					●	●	Visual Basic scripts
		●		●	●	●	Software options

¹⁾ As device version

²⁾ Via integral LEDs

³⁾ Only Mobile Panel 277, but not Mobile Panel 277F IWLAN and 277 IWLAN

⁴⁾ Mobile Panel 277 IWLAN via WLAN

⁵⁾ As SIPLUS extreme component, also for corrosive atmosphere/condensation (www.siemens.com/siplus-extreme)

⁶⁾ As SIPLUS extreme component also for an extended temperature range (-25 °C ... +60 °C) and corrosive atmosphere/condensation (www.siemens.com/siplus-extreme)

WinCC flexible

Maximum configuration efficiency for all applications

The WinCC flexible engineering software allows integrated configuring of all SIMATIC Operator Panels right up to PC-based visualization workstations.

WinCC flexible stands for maximum configuring efficiency: Libraries with off-the-shelf objects, re-usable faceplates, intelligent tools right up to automated text translation in the case of multi-language projects. WinCC flexible is available in different versions graded according to price and performance. They are based on each other and are optimally tailored to the individual classes of operator panels. The larger software package always includes the configuration options of the smaller package. Existing projects can simply be reused.

Minimizing configuration costs by means of function block technology

Reusable objects can be centrally stored in a structured format in libraries. Part of WinCC flexible is a large number of scalable and dynamically variable objects for creating faceplates. Changes to the faceplates only have to be performed at one central location. They then become effective wherever the faceplate is used. This not only saves time, but also ensures data consistency.

Intelligent tools for efficient configuration

Table-based editors simplify the generation and processing of similar types of object, e.g. for tags, texts or messages. Complex configuration tasks such as the definition of motion paths or the setup of the fundamental operator prompting system are simplified by means of graphical configuration.

Real-time operation through PROFINET IO

The new SIMATIC Panels of the 170 and 270 series also support real-time capable PROFINET IO. Thus time-critical conditions, e.g. as implemented over PROFIBUS by means of the DP direct keys, are now also possible based on Industrial Ethernet.

Highlights of SIMATIC WinCC flexible

- Innovative configuration interface based on the latest software technologies
- Function block libraries: Variable blocks are freely definable and reusable, and they can be modified centrally
- Dynamic faceplates
- Intelligent tools, such as screen navigation
- You can graphically configure motion objects and conveniently configure bulk data (e.g. tag editor), etc.
- Access protection with user ID and password
- Recipe management
- Report system
- Language support for worldwide use:
 - Manage 32 languages in one project
 - Text library for multilingual texts and automatic translation
 - Simple import/export of texts for translation
- Individually expandable with options:
 - Sm@rt Client/Server concepts
 - Service and diagnostics over the Internet
 - OPC server communication
 - Process diagnostics
 - Logging and tracking of operator actions and configurations

Operating and display options

Visualization for WinCC flexible is performed using a Windows-compliant user interface with parameterizable screen objects as well as technological faceplates.

Alarms

Alarms can be generated in WinCC flexible as discrete alarms, analog alarms, and alarms by means of the Alarm_S message frame alarm procedure with SIMATIC S7. User-defined alarm classes can be used to define acknowledgement functions and the visualization of alarm classes.

Logs and reports

WinCC flexible permits time and event-driven output of logs and reports. The layout can be freely selected.

Password protection

Access protection can be activated, if required. Administrators can create user groups who have specific privileges.

Logging of process data and alarms

Process value and alarm archiving with WinCC flexible/Archives is used to record and evaluate process data. Process sequences are documented, the capacity utilization or the quality of products is monitored and recurring fault conditions are logged.

Management of recipes

WinCC flexible/Recipes is used to manage recipes which contain associated machine or production data.

Flexibly expandable via options

Remote maintenance simplifies service and support

The option WinCC flexible/Sm@rtService permits access to the PROFINET/Ethernet-compatible Panels and Multi Panels from a PC via Internet Explorer.

An e-mail can also be sent automatically from the operator panel to the maintenance personnel via an SMTP (Simple Mail Transfer Protocol) server. When using an e-mail/text message gateway, access is gained to standard networks and, in critical situations, a text message can be sent to a mobile phone.

OPC for vendor-independent communication

With the WinCC flexible/OPC server option, the Multi Panels are capable of communicating with every OPC-compatible application (e.g. MES, ERP, or office applications) via Ethernet using TCP/IP.

Client/server functionality and plant-wide data exchange

With the WinCC flexible/Sm@rtAccess option, PROFINET-compatible Panels and Multi Panels communicate with each other over PROFINET/Ethernet or the intranet/Internet.

Process error diagnostics for increased plant availability

WinCC flexible/ProAgent permits specific process diagnostics for machines and plants which are controlled by SIMATIC S7. In the case of a process fault, ProAgent acquires information about the location and cause of the fault and supports troubleshooting.

Traceability and easy validation

The WinCC flexible/Audit option covers essential requirements outlined by GMP (Good Manufacturing Practice) and the FDA (Food and Drug Administration) in accordance with 21 CFR (Code of Federal Regulations), Part 11, for applications subject to validation in the pharmaceutical industry.

The creation of new versions and tracking of changes

Any change to the configuration can be recorded and assigned a version number with the WinCC flexible/Change Control option. This fulfills the GMP requirements with respect to change control.

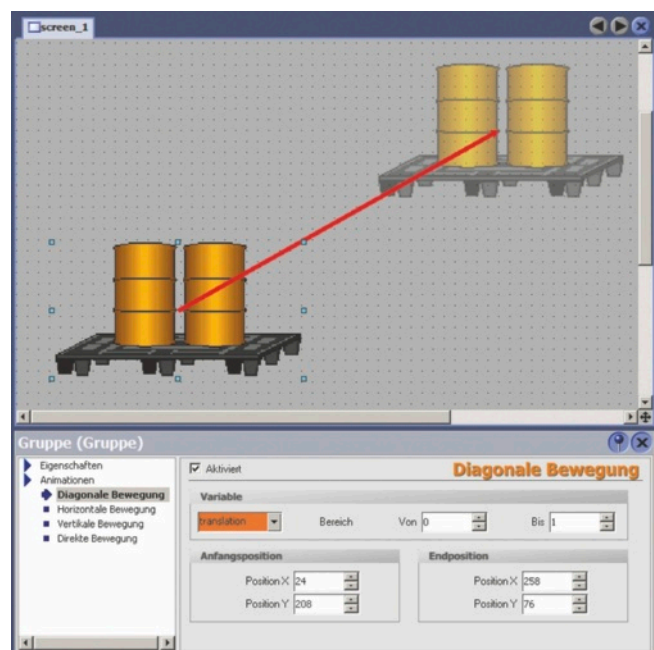
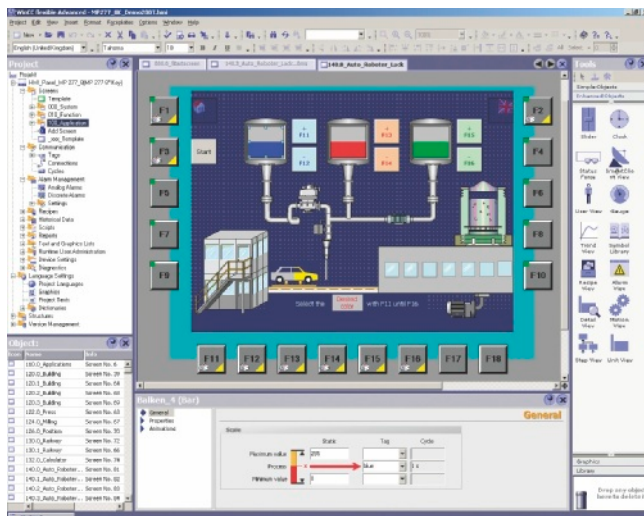

SIMATIC Push Button Panels

The innovative operator panels

SIMATIC Push Button Panels can be used for creating conventional operator panels according to the principle of "plug and control": They are ready for installation and pre-assembled. In this way, time-consuming individual assembly and wiring, as required for conventional operator panels, is not necessary. This reduces the time required for wiring by up to 90 % compared to conventional wiring. All that is required is the corresponding installation cutout and a bus cable (PROFINET, PROFIBUS DP, or MPI) for connection to the controller.

SIMATIC Push Button Panels¹⁾ can be connected via:

- PROFINET
- PROFIBUS DP as standard slave with up to 12 Mbit/s to any DP master (including third-party masters)
- MPI to SIMATIC S7-200/-300/-400 (does not apply to PP17-I PROFI-safe)

PP17-I PROFI-safe

Push Button Panel with 16 illuminated short-stroke keys and free, digital inputs and outputs, supplemented with fail-safe input channels (F-DI) for simple emergency stop applications.

With the help of the integrated PROFI-safe communication, the operator panel can be used for fail-safe operation with SIMATIC S7-F-CPU 300/400 for simple emergency stop applications. Up to 2/4 two-channel emergency stop buttons can be connected. The safety-relevant signals can achieve SIL3/Category 4 (with PROFIBUS) or SIL3/PL e, Category 3 (with PROFINET). The external dimensions and installation cutout are the same as for the PP17-I.

Highlights of the SIMATIC Push Button Panels

- Preassembled short-stroke keys with long-life multicolored surface LEDs
- All keys can also be used as individual switches
- Integrated flashing frequencies and adjustable signal extension
- Up to 16 DI/16 DO onboard for flexible expansions, e.g. for keys or lamps
- Perforated 22.5 mm cutouts for integrating standard elements, e.g. buttons, lamps, emergency stop or key-operated switches
- Slide-in labels for individual labeling
- Can be installed next to and combined with SIMATIC Panels
- Central enable input
- Service-friendly
 - Maintenance-free, because it needs no battery
 - Permanently integrated test functions, such as the lamp test

Additionally with PP17-I PROFI-safe

- 1 to 4 F channels for emergency stop with PROFIBUS, 1 to 2 F channels for emergency stop with PROFINET
- Up to 14 free digital inputs (depends on the number of connected emergency stop buttons) with PROFIBUS, 16 free digital inputs with PROFINET
- Up to 14 free digital outputs (depends on the number of connected emergency stop buttons) with PROFIBUS, 8 free digital outputs with PROFINET

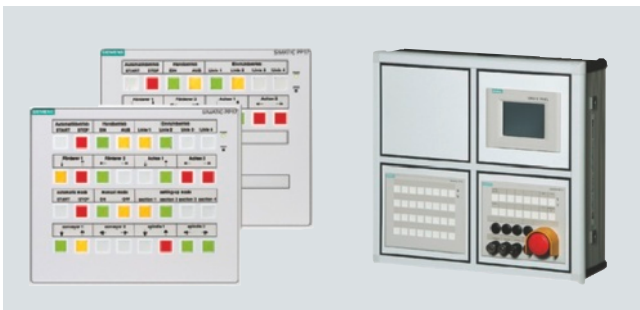

Push Button Panels, PP17-I and PP17-II

PP17-I PROFI-safe – installed in the operator station

¹⁾ Push Button Panels are also available in a SIPLUS extreme version for extreme environmental conditions (e.g. use in corrosive atmosphere/with condensation). Further information: www.siemens.com/siplus-extreme

SIMATIC Micro Panels

Simple and low-cost operator control with the SIMATIC S7-200

The S7-200 micro system is compact, modular, and has a variety of communication ports. For this reason, it is suitable for many diverse automation tasks. The Micro Panels are optimally adapted to the performance and applications of the S7-200.

They are available as text displays which are configured with SIMATIC Micro/WIN, but also as operator panels and touch panels with graphic displays configurable with WinCC flexible.

The Touch Panel TP 177micro has a 5.7" STN display with 4 blue levels and a touch screen. Vertical (portrait) setup offers additional display options for process screens.

Coupling options

The SIMATIC Micro Panels are connected to the S7-200 with a standard MPI or PROFIBUS cable. In addition, multi-master communication, e.g. for connection to networks, is possible.

The device range at a glance

SIMATIC TD 100C

- FSTN display, 4 lines
- 14 freely configurable keys
- The layout of the user interface is freely configurable
- Display of message texts



SIMATIC TD 200¹⁾

- LC display, 2 rows
- 8 freely configurable keys, 5 system keys
- Display of message texts

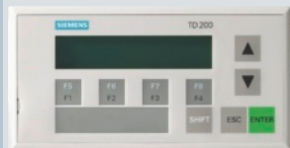

SIMATIC TD 200C¹⁾

- LC display, 2 rows
- 20 freely configurable keys
- The layout of the user interface is freely configurable
- Display of message texts



The device range at a glance

TD 400C²⁾

- LC display with 4 lines of 24 characters each
- 15 freely configurable keys
- The layout of the user interface is freely configurable
- Press of a button with tactile, audible or visual feedback



Devices that can be configured using WinCC flexible

SIMATIC OP 73micro

- Pixel graphics 3" display
- 4 freely configurable keys, 8 system keys

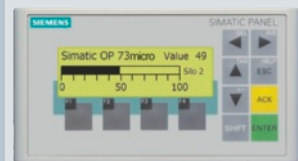

SIMATIC TP 177micro

- Pixel graphics 5.7" display
- Touch screen
- Vertical installation possible
- Further graphics options through vector graphics
- Trend display



¹⁾ As SIPLUS extreme component also for an extended temperature range (-25 °C ... +60 °C) and corrosive atmosphere/condensation (www.siemens.com/siplus-extreme)

²⁾ As SIPLUS extreme component also for an extended temperature range (-10 °C ... +60 °C) and corrosive atmosphere/condensation (www.siemens.com/siplus-extreme)

Detailed information on Micro Panels can be found at:
www.siemens.com/micropanels

SIMATIC Mobile Panels

Maximum mobility for operator control and monitoring

Regardless of the industry or application, if mobility is required for on-site control and monitoring of machines and plants, mobile panels offer some crucial advantages: The machine operators or commissioning engineers are able to work exactly where they have the best view of the workpiece or process.



New: Device with 10" touch display for clear representation of complex process mimics

Compact and ergonomic design

With its low weight and handy, compact structure, the Mobile Panel is easy to handle. It permits different holding and gripping positions and can be easily operated for longer periods both by right-handed and left-handed people.

Rugged design for industrial use

Thanks to the double-walled structure and the rounded casing, SIMATIC Mobile Panels are extremely shock-resistant. For example, they can survive a fall from a height of more than one meter without damage. The STOP button in particular is protected with a "protective collar". This minimizes the possibility of unintentional triggering of the safety function or the risk of damage when the device is dropped. SIMATIC Mobile Panels are completely dust-proof and splash-proof (IP65 degree of protection). The high requirement for ruggedness also comprises the connection box and cable.



Mobile Panel 177 (left) or 277 (right) – the right model for every application – also with PROFINET/Ethernet connection

Highlights of the Mobile Panels

- Rugged design for industrial use
- Ergonomic, compact and light-weight
- Flexible thanks to hot swapping
- Insertion and removal without interrupting the emergency stop circuit (with Plus connection box)
- Reliable operation with sophisticated safety concept
- Connection point detection
- Integrated interfaces: Serial, MPI, PROFIBUS or PROFINET/Ethernet
- Short device startup time after docking

Reliable and secure operation

Operation takes place intuitively via the touch screen or membrane keys, which provide perceptible and thus reliable feedback – even when the operator is wearing gloves.

For time-critical operation and control processes with very short response times the membrane keys and touch screen can also be connected directly to the distributed I/O. Even the additional control elements can be configured as direct keys.

With the optional wall bracket, the Mobile Panel can be securely stored or used as a stationary terminal.

Innovative connection solutions

The Mobile Panel is simply plugged into the connection box wherever it is needed on the machine and is immediately ready for use. The rugged and safe connection box with IP65 degree of protection can be mounted anywhere, even outside the control cabinet. It ensures fault-free hot-swapping.

Fast device startup

The Mobile Panels are characterized by a fast device startup after plugging them into the connection boxes. By using an optional battery pack, the startup time of the Mobile Panel – after a short period of separation from the connection box – can again be significantly reduced.

Connection point detection

The SIMATIC Mobile Panel can be configured such that the user interface changes according to the connection point. The connection point is clearly detected when the Mobile Panel is plugged into the connection box. This enables machine-specific HMI authorizations or actions to be performed depending on the selected connection point.

Integrated interfaces

Mobile Panels are available with PROFIBUS and PROFINET/Ethernet connection. The connecting cable can be up to 25 meters long. The interfaces are already integrated and a variety of drivers – even for non-Siemens PLCs – are also included in the scope of supply. The PROFINET connection boxes can be connected in series with integrated switches.

Sophisticated safety concept

SIMATIC Mobile Panels offer the option of making safety functions available on a mobile basis at any point of a machine or plant. They have two acknowledgement buttons which ensure the protection of personnel and machines in critical situations (dead man's switch). The acknowledgement buttons are integrated into the handle on the back.

Device models with an additional STOP button can be wired into the emergency stop circuit of a machine or plant by means of the connection boxes.

In this way, the STOP button offers the functionality of an emergency stop button, but differs visually from conventional emergency stop devices due to its gray color to avoid confusion.

STOP and acknowledgement buttons are designed with dual circuits according to the safety regulations (EN 60204-1). This means it is possible to achieve Safety Category 3 according to EN 954-1.

Connection at one point of the machine

The "Basic" connection box is used for connecting SIMATIC Mobile Panels with STOP button to one point of the plant. The disconnection of the device in this case causes an opening of the emergency stop circuit and thus triggers the emergency stop.

Variable connection to different stations of a machine or plant

If you use a Mobile Panel with STOP button together with a "Plus" connection box, a configuration can be set up in which the Mobile Panel can be used at different connection points.

When the Mobile Panel is connected, the device is looped into the emergency stop circuit. The emergency stop circuit remains closed regardless of whether the Mobile Panel is plugged in or disconnected. If the Mobile Panel is disconnected during operation, the emergency stop circuit in the Plus connection box is automatically closed which prevents triggering of the emergency stop circuit.

The Plus connection box is also available in a SIPLUS extreme version for extreme environmental conditions (e.g. use in corrosive atmosphere/with condensation).

Further information: www.siemens.com/siplus-extreme

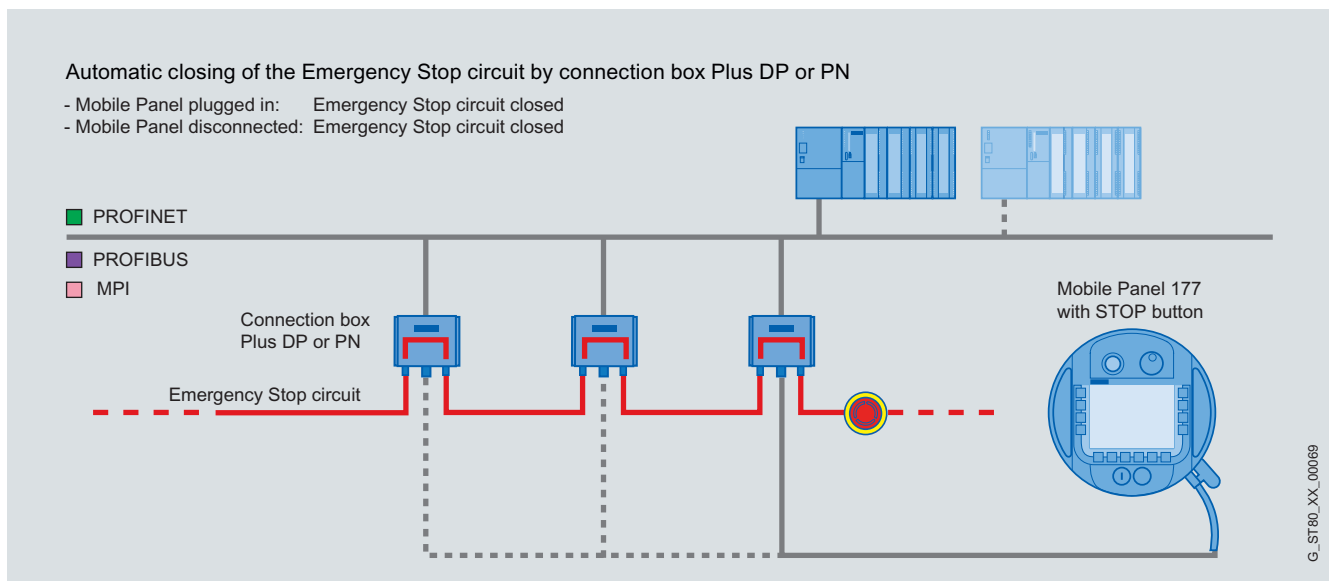

Variable connection to different stations, using the Mobile Panel 177 on the PROFIBUS as an example

Maximum mobility in operator control and monitoring – wireless and with complete safety functionality

The SIMATIC Mobile Panel 277(F) IWLAN is a worldwide novelty in the field of operator control and monitoring: a wireless operator panel with full HMI functionality. Two versions are available: one device for wireless operator control and monitoring without safety functionality and one with safety functionality. In addition there is the option of using the SIMATIC Mobile Panel 277 (F) IWLAN for SIMOTION applications as well.

Certified safety

The SIMATIC Mobile Panel 277F IWLAN has two acknowledgement buttons and one emergency stop button. A fail-safe SIMATIC F-CPU must be used to be able to utilize the safety functions. For industrial systems, the use of SIMATIC Industrial Wireless LAN is recommended.

The suitability of the device for particularly high safety requirements was tested and certified by TÜV (SIL 3). The necessary radio approvals already exist for worldwide use.

Definite effective ranges

The SIMATIC WinCC flexible engineering software can be used to define ranges from which the machine with acknowledgement buttons can be operated. Within these "effective ranges", the device is identified by means of transponders or in an additional version by means of economical RFID tags (Moby D smart cards). This ensures reliable operation and the clear assignment of suitable operating screens and operator authorizations from any point in the plant.

Location-dependent behavior can also be defined for the SIMATIC Mobile Panel 277 IWLAN (without safety function). Here the transponder can generate zones where specific functions are configured, e.g. an automatic screen display or operator authorizations for specific persons.

Rugged for tough industrial environments

With its IP65 degree of protection and a drop height of over one meter, the device can be optimally used in tough industrial environments. The powerful batteries can be replaced without interrupting operation. This ensures trouble-free operation.

WLAN area and effective range

The WLAN area is the area in the plant where the operator panel communicates with an access point over a wireless local area network.

As soon as the PROFINsafe communication between the controller and operator panel is established in the WLAN area, the emergency stop button on the operator panel becomes active.

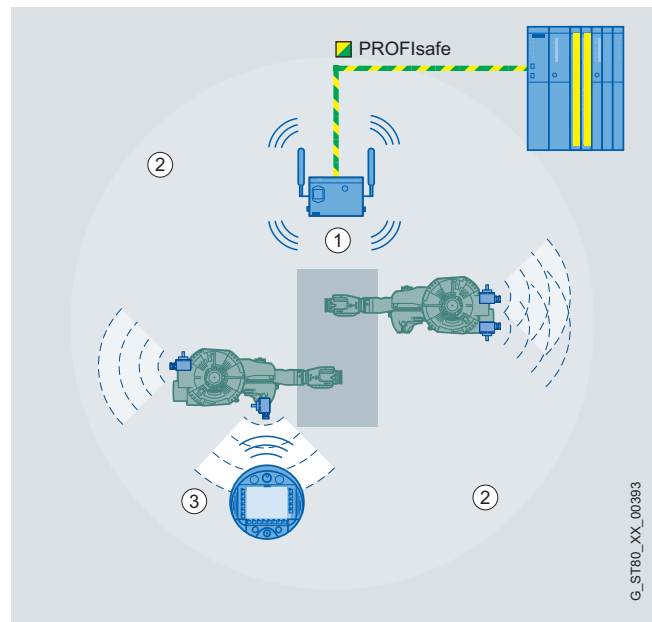

- 1 Access point as network gateway from WLAN to the PROFINET
- 2 WLAN area in which communication with the SCALANCE W access point is possible
- 3 Mobile Panel in the effective range/zone

Fail-safe operation of the plant with the acknowledgement buttons only becomes possible when the operator panel is logged on in an effective range (defined by transponders or RFID tags) within the WLAN area. Due to its high safety standard, the device satisfies safety category SIL 3.

Rapid Roaming

The Mobile Panel 277F IWLAN communicates by means of the extended WLAN access procedure iPCF-MC (industrial point coordination function with management channel). This procedure – also known as "rapid roaming" – ensures uninterrupted handover of the wireless signals between the individual access points.



Mobile Panel 277F IWLAN (left) and 277 IWLAN (right)

SIMATIC Basic Panels

Low-cost operator control and monitoring for simple applications

The process quality can be significantly improved with visualization even in the case of small machines or simple applications. Despite this, however, the human machine interface option has until now frequently remained unused for cost reasons.

The new SIMATIC Basic Panels offer HMI basic functions at an attractive price and thus open up new possibilities for mechanical engineering.

Clear representation on high-contrast color displays

SIMATIC Basic Panels are available with 4" to 15" touch displays for intuitive operator control. Most devices also have freely configurable keys with tactile feedback. With an IP65 degree of protection, Basic Panels are also suitable for use in harsh environments.

Integral functionality

The software functions are independent of the display size: Signaling system, recipe management, trend curve functionality, and language switching are available in all cases.

Different communication options

The Basic Panels communicate as standard using PROFINET/Ethernet or PROFIBUS.

Upgradability is ensured

Basic Panels are configured with WinCC flexible. Existing projects can thus be transferred to another SIMATIC Panel, Multi Panel or also to a PC, in the event of an upgrade. The matching installation cutouts of Basic Panels, Panels and Multi Panels make it possible to equip the same machine with the level of HMI functionality desired by the customer, or to change from one Basic Panel to a more powerful SIMATIC Operator Panel at a later time.

Operating and monitoring of microcontrollers

The new SIMATIC STEP 7 Basic engineering system allows integrated engineering for the new S7-1200 microcontrollers and Simatic HMI Basic Panels. Simatic Step 7 Basic V10.5 with integrated WinCC Basic for visualization tasks supports the user with task-oriented and intuitive editors for a high degree of operator-friendliness and efficiency in engineering.

Highlights of the Basic Panels

- Field-proven SIMATIC quality
- Ideal for simple visualization tasks
- Displays with touch functionality for intuitive operator control
- Freely configurable keys with tactile feedback
- Versions for connecting to PROFINET/Ethernet and PROFIBUS
- Upward-compatible WinCC flexible projects
- Installation-compatible with SIMATIC Panels and Multi Panels



SIMATIC Panels – 70 series

Low-cost operator control using rugged keys

The SIMATIC Panels of the 70 series¹⁾ are the low-cost entry-level devices in the range of graphics-capable operator panels. They are ideally suited to small-scale HMI tasks.

The pixel-graphics display can be used for the graphical display of the processes using, for example, bit maps or bar graphs. The font size can be varied to achieve excellent readability even from a distance. Symbols or text can be used for labeling the function keys. This enables intuitive user interfaces to be created and saves translation work.

Connection to controller

The OP 73 and OP 77A/B can be connected to SIMATIC S7-200/-300/-400. The OP 73micro version has been specially designed for SIMATIC S7-200. Drivers for interfacing to a range of different controllers are also available for the OP 77B. The necessary interfaces are already onboard.

Three devices are available:

- SIMATIC OP 73 Operator Panel with 3" graphics display (160 x 48 pixels)
- SIMATIC OP 77A and OP 77B Operator Panel with 4.5" graphics display (160 x 64 pixels)

As the most powerful panel in the 70 series, the OP 77B includes simplified data handling and more communication options than the OP 73 and OP 77A.

Simple data handling for OP 77B

Using a generally available Multi Media Card, the memory available for recipe data and project back-up can be expanded significantly with the OP 77B. The recipes can be stored in standard format (CSV) for further processing in the PC using, for example, Excel. Back-up and restore functions for the complete project allow panels to be replaced easily in the event of a fault, for example.

¹⁾ Panels of the 70 series are also available in a SIPLUS extreme version for extreme environmental conditions (e.g. use in corrosive atmosphere/with condensation). Further information: www.siemens.com/siplus-extreme

Highlights of the SIMATIC Panels of the 70 series

- 3" or 4.5" pixel graphics displays also support bitmap and bar displays
- Compact, space-saving design (installation cutout as for the predecessor versions OP3 or OP7)
- MPI and PROFIBUS onboard
- 5 online languages, also Asian and Cyrillic characters
- Graphical labeling of soft keys possible
- New powerful functions, e.g. comprehensive alarm concept with freely-definable alarm classes

Additional communication options for OP 77B

The OP 77B features a USB interface for connecting a printer or downloading a project.

The project can also be loaded to the device over the RS 232 interface or from a central location via MPI or PROFIBUS. Remote download of the configuration, for example, via a modem or with SIMATIC TeleService saves money and time during servicing.



SIMATIC Panels – 170 series

The all-rounders with comprehensive basic functionality

The Touch Panels and Operator Panels of the 170 series¹⁾ have proved themselves for operator control and monitoring of small applications. The performance capability of the devices is scalable. These higher-quality devices have a retentive message buffer, and the color devices also have a PROFINET/Ethernet interface.

SIMATIC TP 177A – Operator control and monitoring at a favorable price

The Touch Panel TP 177A stands out due to its especially favorable price/performance ratio. It facilitates the use of graphics-capable operator panels with intuitive touch operation, even for small projects and on low budgets.



SIMATIC TP 177B and OP 177B – intuitive and innovative

The TP 177B and OP 177B are available with 4 blue mode or 256-color STN displays. The OP 177B with additional, rugged membrane keyboard has been designed for applications that cannot do without mechanical keys. The function keys can additionally be configured as system keys as desired. As a special feature, the OP 177B also has a touch display.



The TP 177B with a 4" display in widescreen format is a new addition. It is characterized by compact installation dimensions, despite which it still offers around a third more visualization surface than comparable devices on the market.

TP 177A highlights

- Pixel-graphics 5.7" STN display, blue mode (4 levels)
- Vertical (portrait) installation possible (resolution 240 x 320 pixels)
- Signaling system with freely definable message classes (status/fault messages) for defining acknowledgment behavior and presentation of the alarm events
- Vector graphics, plots
- Functions for switches, indicator lamps, password protection, displays, bar charts, input and output fields, predefined texts, etc.
- Recipes
- Long service life of the backlighting

TP 177B and OP 177B highlights

- Choice between touch or key operation. OP 177B combines touch and key operation
- Non-volatile message buffer (without battery, therefore maintenance-free)
- Function keys can be assigned system key functions and configured as direct keys
- 2 Mbyte user memory plus additional integral recipe memory
- 12 Mbyte onboard PROFIBUS interface
- Color versions feature an additional PROFINET/Ethernet interface
- Interface for standard Multi Media Card
- USB interface, e.g. for printer connection

TP 177B 4" highlights

- 4.3" TFT touch display with 256 colors in widescreen format 16: 9 (480 x 272 pixels): improved display options in minimum space
- Combination of touch display and tactile keys
- PROFIBUS and PROFINET at an especially favorable price
- Dimmable backlighting (20 to 100 %)

¹⁾ Panels of the 170 series are also available in a SIPLUS extreme version for extreme environmental conditions (e.g. use in corrosive atmosphere/ with condensation). Further information: www.siemens.com/siplus-extreme

SIMATIC Panels – 270 series

The universal devices with high-contrast TFT displays

Based on the Windows CE operating system, the devices of the 270 series¹⁾ offer innovative operator control and monitoring combined with the tried and tested advantages of the Operator Panels and Touch Panels: **Ruggedness, stability and simple handling.**

A number of options for innovative automation and operator concepts can be utilized during configuration with WinCC flexible. Standard hardware and software interfaces ensure more flexibility and openness and access to the office world. Archive data, for example, can be loaded directly into Excel and then processed further.

SIMATIC TP 277

The SIMATIC Touch Panel TP 277 for operator control and monitoring at the machine level is available with a brilliant 6" TFT display. In addition to its optimized performance, the device also features USB, MPI/DP, and PROFINET/Ethernet interfaces. The 4 MB user memory can be expanded for archives and recipe data by means of the Multi Media Card slot.

SIMATIC OP 277

Das SIMATIC OP 277 Operator Panel is operated by means of a membrane keyboard, otherwise it has the same functionality as the TP 277.

¹⁾ TP/OP 277 Panels are also available in a SIPLUS version for extreme environmental conditions (e.g. use in corrosive atmosphere/with condensation). Further information: www.siemens.com/siplus-extreme

TP/OP 277 highlights

- Standard interfaces for more flexibility
 - Multi Media Card Slot for memory expansion or additional interfaces
 - PROFINET/Ethernet interface
 - Integrated USB interface for connection of I/O devices which are approved for Windows CE (keyboard, mouse, printer)
- Retentive data memory
- Standard Windows CSV file format for further processing of the data with standard tools
- Visual Basic scripts
- Archives, recipes

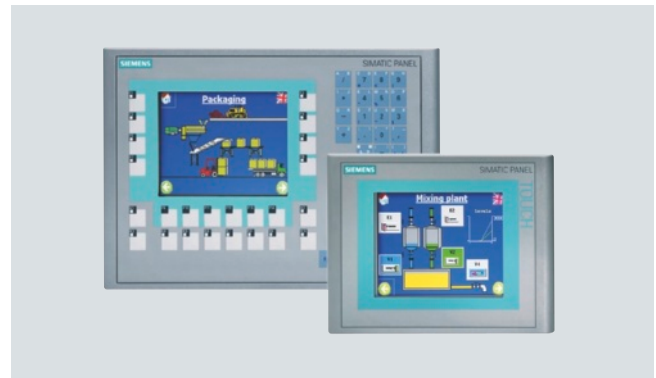

SIMATIC OP 277 6" key device and TP 277 with 6" touch display

SIMATIC Multi Panels – 170/270/370 series

More than just operator control and monitoring

Thanks to the Windows CE operating system, the multi-functional platforms offer PC-like openness and flexibility combined with rugged, compact, and cost-optimized hardware. Without hard disk and fan, the SIMATIC Multi Panels can be used for visualization even where high vibrations or dust-laden atmospheres restrict the use of a PC.

Multi Panels¹⁾ are distinguished by their high performance, openness and expandability, and permit integration of additional software applications based on standard Windows CE. This means the Multi Panels can combine several automation functions on a single platform. HTML documents for operating or work instructions, for example, can be displayed with the help of the Microsoft Internet Explorer (preinstalled). It can be configured which Internet/intranet pages are accessible.



SIMATIC MP 277 10" key device and MP 277 with 10" touch display

Individual function expansions

- Additional functions can be configured with Visual Basic scripts. Logic operations, loops, and decisions, for example, can also be executed outside the controller. More complex functional expansions for customer-specific requirements can be implemented via ActiveX components.
- The WinAC MP option is a software PLC under Windows CE. WinAC MP runs simultaneously with WinCC flexible. Thus the Multi Panel becomes a cost-effective solution for visualization and control tasks. Ruggedness is ensured due to the fan-free and diskless hardware of the Multi Panels. Process data is backed up automatically in case of a power failure. WinAC MP is available in versions optimized for the performance of the Multi Panels. They are configured and programmed with STEP 7. The I/O is connected to the controller over PROFIBUS DP. WinAC MP can be purchased individually or even more cost-effectively together with a Multi Panel.

Highlights of the Multi Panels

- Rugged design with no rotating media
- HTML documents can be accessed from HMI applications with Internet Explorer
- High memory capacity with additional memory expansion possible by means of card slots, e.g. for archives or recipes, backup/restore
- Onboard MPI, PROFIBUS, PROFINET/Ethernet and USB interfaces
- Brilliant TFT display with 64 K colors
- Modular expansion possible with options, e.g.
 - SIMATIC WinAC MP software PLC
 - OPC server for vendor-independent communication
 - Sm@rtService for remote maintenance and service over the Intranet/Internet
 - Sm@rtAccess for getting started with client/server functionality
 - ProAgent for visualizing process diagnostics messages
 - Audit for traceability and simple validation

Central data or project management

Access to the office world is opened up by networking the Multi Panels using PROFINET/Ethernet. Archives and recipes can be stored and managed centrally on the higher-level computer, and data can be exchanged without problems. For print functions, the Multi Panels can use printers integrated into the network.

¹⁾ Multi Panels are also available in a SIPLUS version for extreme environmental conditions (e.g. use in corrosive atmosphere/with condensation).

Further information: www.siemens.com/siplus-extreme

SIMATIC Multi Panels – 170/270/370 series

SIMATIC MP 177 ¹⁾

The MP 177 is suitable as the entry-level Multi Panel. It is already equipped with the innovative Windows CE5.0 operating system, and it corresponds largely to the MP 277 in functionality. The high-resolution TFT touch display represents 64 K colors and has a diameter of 5.7". For applications that do not require archives and scripts, the MP 177 offers a low-cost alternative to the MP 277.

A PROFINET/Ethernet interface, a PROFIBUS DP/MPI interface (RS484/422) and a USB interface are onboard.

As with the MP277, the retentive message buffer offers benefits to both operators and service personnel.

SIMATIC MP 277 ¹⁾

With the option of creating archives and integrating additional functions via scripts, the MP 277 is suitable for more demanding tasks.

MP 277 Multi Panels are available in the following variants:

- 7.5" touch display
- 7.5" display and membrane keyboard
- 10.4" touch display
- 10.4" display and membrane keyboard

The high-resolution TFT displays display 64 K colors.



SIMATIC MP 277 with 10.4" display and membrane keyboard

¹⁾ MP 177 are also available as a SIPLUS extreme version for extreme environmental conditions (e.g. for use in corrosive atmosphere/condensation). Further information: www.siemens.com/siplus-extreme

SIMATIC MP 377 ¹⁾

The MP 377 Multi Panels fulfill the highest performance requirements for complex applications. They are equipped with the innovative Windows CE 5.0 operating system. It was possible to achieve increased performance compared to the predecessor version MP 370. The retentive message buffer offers benefits to both operators and service personnel. Since the latest technologies are utilized for the interfaces (PROFINET, 2 x USB 2.0, MMC/SD card slot), a maximum degree of investment protection is ensured.

MP 377 Multi Panels are available in the following variants:

- 12" touch display
- 12" display and membrane keyboard
- 15" touch display
- 19" touch display

The high-resolution TFT displays display 64 K colors.



SIMATIC MP 377 with 12" display and membrane keyboard

The integrated Microsoft Media Player provides multimedia functionality and permits the display of videos. In addition to an expanded Internet Explorer, Word documents, Excel tables, and PDF documents can be displayed in the Microsoft Viewers.

Accessories for SIMATIC Multi Panels

A rugged USB hub with IP65 degree of protection with 4 interfaces that can be accessed at the front or rear is available for the new Multi Panels. This hub permits the quick connection of I/O devices such as USB flash drives and printers without having to open the control cabinet door and possibly interrupting the plant operation.

SIMATIC Thin Clients

Low-cost operator stations on site in distributed systems

Thin Clients are low-cost operator terminals that provide panel functionality on site in large or extensive systems and thus they contribute to an enhanced overview, operability, and productivity of the plant.

SIMATIC Thin Clients are low-cost operator stations that can be used in large plants in addition to SIMATIC Panels or Panel PCs. As remote operator terminals, they also allow for the use of SCADA, office or IT functionalities directly on site at the machine in addition to HMI connection. Their installation cutout and design are compatible with Multi Panels of the corresponding size. SIMATIC Thin Clients are always operated using a touch screen or via an external keyboard or mouse connected to the USB interface.

SIMATIC Thin Clients always communicate with a host (SIMATIC Panel, Panel PC or server) via Sm@rtAccess (screen copy of panel on the client) or the Microsoft standard RDP (Remote Desktop Protocol), and therefore do not require installation, licenses or additional software on the unit itself. Larger distances from the host can also be covered over Ethernet.

Easy commissioning

SIMATIC Thin Clients require only one IP address. Local software installation or configuring are not required. The display and user interface are provided by the host. Therefore the client also does not have to implement backup, restore, or update actions. The total costs of ownership are correspondingly low.

High degree of ruggedness

As a remote operator terminal without a hard disk and fan, the device can be operated on machines with particularly high mechanical ruggedness requirements (e.g. vibration resistance).

You will find information on an all-round IP65-protected version on page 23.

On-site host functionality

HMI applications such as WinCC or WinCC flexible as well as Office applications such as MS Excel or SAP can be operated direct at the SIMATIC Thin Client on the machine on site over the RDP connection. Unlike with Microsoft CE Office Viewers, the data can be written. RDP is a standard protocol that is supported by all Windows operating systems.

Integrated communication

SIMATIC Thin Clients can be integrated in PROFINET/Ethernet networks. Alternatively, a point-to-point connection to the host is possible using Ethernet cables. Distances of up to 100 m (even more with switches) can be bridged. This is considerably more than with conventional operator panels connected over USB-DVI.

Typical SIMATIC Thin Client application scenarios

- WinCC, installed on server systems, can be displayed and operated on Thin Clients by means of the Remote Desktop Protocol (RDP). Thin Clients prove their worth in this case as rugged and low-cost distributed operator stations. Thin Clients with complete IP65 protection permit operator control and monitoring since they can be flexibly mounted and set up as required outside of the control cabinet even in harsh environments.
- WinCC flexible, installed on SIMATIC Multi Panels or SIMATIC PCs, can be displayed and operated on Thin Clients by means of the option Sm@rtAccess. In this case as well, Thin Clients can be used as low-cost local operator stations. This can be of interest if the same process needs to be controlled from several locations in the plant.
- Access to HTML pages on the web is possible by means of the integrated browser. Thin Clients prove their worth in this case as additional web terminals for Intranet/Internet applications.

SIMATIC Thin Client	10"	15"
Display	TFT, 64 K colors	TFT, 64 K colors
Resolution	640x480 (VGA)	1024x768 (XGA)
Can be installed with	MP 277 (10"), MP 370 (12")	MP 370 (15")
Interfaces	USB (on the rear), PROFINET/Ethernet, 24 V power supply	
Terminal connection	Sm@rtAccess, RDP (Microsoft)	
Web connection	HTML, HTTP, JavaScript	
Degree of protection	IP54, IP65 (optional) at the front	



SIMATIC Panels with stainless steel front

To meet the highest demands for safety and hygiene

Panels with touch screens and stainless steel fronts are designed for operator control and monitoring of food processing machines in the food, beverages and tobacco industry. They are based on DIN EN 1672-2 "Food processing machinery – Safety and hygiene requirements".

The external dimensions and installation cutout are the same as for standard products. The optimized frame is almost flush with the control cabinet.

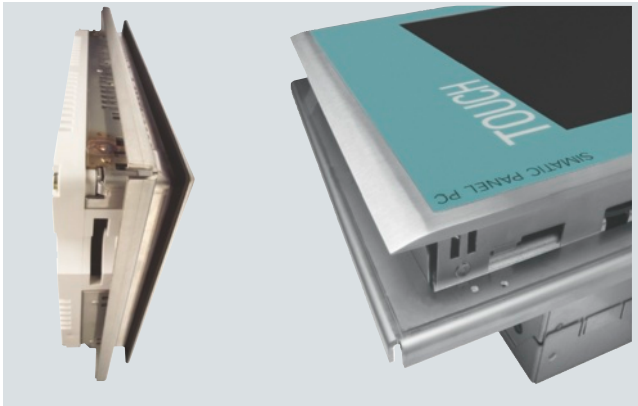

The highlights of panels with stainless steel front

- Resistant and rugged stainless steel fronts with polished surface for easy cleaning
- Optimized rack design with slight projections to the cabinet and for allowing liquids to run off
- Minimized grooves and gaps as well as increased resistance to cleaning and disinfection agents
- Non-migrating, food-standard sealing material (flat seals to FDA 21 CFR 177.2006) and display splash protection to avoid contamination by foodstuffs
- The device front is based on DIN EN 1672-2
- Decorative foil, resistance against chemicals tested according to DIN 42115, Part 2
- IP66 degree of protection (IP66K in part)
- ATEX approval

Special properties of the SIMATIC Panels with stainless steel front



	TP 177B color PN/DP INOX	MP 277 10" Touch INOX	MP 377 15" Touch INOX	Panel PC 677B INOX
Front				
Material/surface	Stainless steel 1.4301, polyester foil/polished, grain size 240			
Seal	EPDM			
Special features	Optimized frame design, inclined surfaces			
Ambient conditions				
Degree of protection	Front: IP66K, NEMA 4, 4 x and 12, on the rear: IP20	Front: IP66K, NEMA 4, 4 x and 12, on the rear: IP20	Front: IP66K, NEMA 4, 4 x and 12, on the rear: IP20	Front: IP66K, rear: IP20
Ambient temperature during operation	Vertical mounting: 0 ... 50 °C; max. angle of inclination: +/- 35°: 0 ... 40 °C			+5 °C ... 50 °C in maximum configuration
Relative humidity	Max. 85 % (no condensation)			
Transport/storage temperature	-20 °C ... +60 °C			
Approvals	FM Class 1 Div 2, cULus, CE, C-Tick, Ex-Zone 2/22	FM Class 1 Div 2, cULus, CE, C-Tick, Ex-Zone 22	FM Class 1 Div 2, cULus, CE, C-Tick, Ex-Zone 2/22	cULus, CE
Dimensions				
Front plate W x H (in mm)	212 x 156	335 x 263	400 x 310	483 x 310
Installation cutout W x H (in mm)	198 x 142	310 x 248	368 x 290	450 x 296
Weight	Approx. 1.5 kg	Approx. 4.2 kg	Approx. 7 kg	Approx. 15 kg
Special features	Clamping frame on the rear side			

Fully protected HMI devices

For flexible use on a supporting arm or stand

The new HMI devices with all-round protection supplement the portfolio of the tried and tested built-in units with rugged operator panels in a slim and appealing design. The devices are designed for mounting on a stand or supporting arm and feature all-round IP65 protection.

The series is technically based on available built-in devices:

- SIMATIC Flat Panel Monitor PRO 15" – the brilliant, rugged industrial display at an attractive price; up to 30 m away from the PC
- SIMATIC Thin Client PRO 15" – ideal as second operator station for cost-optimized automation concepts with Thin Client technology
- SIMATIC Multi Panel 377 PRO 15" – with maximum performance, optimized for the SIMATIC WinAC MP software PLC and expandable by means of software options.

All devices feature a brilliant 15" touch display and can be flexibly mounted onto many different supporting arm and stand systems. Thus they can be optimally used on machines without requiring a control cabinet. This permits ergonomic operation at different locations in plants or at production lines. The devices are connected to supporting arm systems from different manufacturers by means of adapters, optionally on the top or bottom of the device. Both options are provided as standard.

Due to their low weight, the HMI devices with all-round protection can be mounted easily and quickly. The backplane can be removed easily – e.g. for subsequent installation of cables or replacing memory cards – and thus ensures a high degree of service friendliness even when the device is already mounted on the machine.

Modular expansions

The new, modular expansion units perfectly supplement the completely protected HMI devices and ideally match the attractive design.

They can be attached optionally on the right, on the left, or above or below the operator panels. The IP65 degree of protection is retained for the entire system even after installation. The expansion units can be equipped individually with switches or illuminated pushbuttons, and they thus open up operator control options such as emergency off (also PROFIsafe) or plant-specific, mechanical control elements.

Highlights

- Operator panels with all-round IP65 protection for mounting on supporting arms or stands
- Removable backplane hood for optimum service friendliness.
- Maximum compactness and low weight for easy mounting
- Easy adjustability to changing requirements thanks to modular expansions



Customer-specific solutions

The technical design of SIMATIC Panels is oriented toward the requirements of all industries. Individual SIMATIC Panels meet specific requirements.

There are also SIMATIC Panels based on standard products which are tailored to individual customer requirements. Panels can be adapted to the machine design as follows:

- Customized design
- Use of the company name instead of the Siemens logo and modification of the type designation
- Different housing color
- Customer-specific hardware modifications such as the design and dimensions of the front plate, selection of the display, memory configuration, drives, options
- Customer-specific Panel PC configuration as a rugged embedded hardware and software system, without hard disk and with tailor-made software
- Customer-specific software suite with choice of Windows operating systems
- Customer-specific applications for Windows CE-based panels (Open Platform Program)
- Device mounted in a stainless steel cabinet as a ready-to-install and ready-to-connect terminal that is ergonomic, functional, and with high degree of protection and tested heat dissipation (e.g. all-round IP66 degree of protection)
- Tested hygiene with LGA test mark 5664018.

HMI operator stations

Complete HMI operator stations can be used wherever HMI devices cannot be installed in a control cabinet or directly at the machine.

The HMI operator station concept is based on a modular design where HMI devices can be installed according to function in selected housings.

- HMI device encapsulation for all-round protection (IP65)
- Can be mounted on a stand or supporting arm.
Can be rotated with the help of adjusting elements
- Possible connection of external keyboard and mouse
- Installation option for specific hardware components.

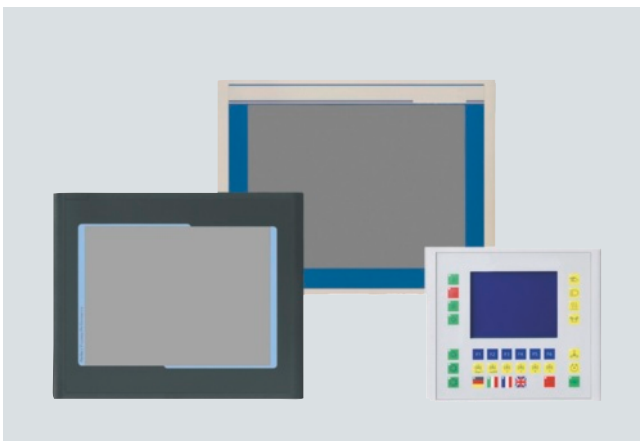

Accessories for SIMATIC Operator Panels

Memory media



panels with Windows CE 5.0 or higher.

Data such as the operating system, projects, license keys, etc. can be saved and transferred via various types of standard storage media. The selection of storage media for SIMATIC HMI ranges from Compact Flash cards and Multi Media Cards to the SD card. Standard USB flash drives are approved for all of the

Converters/adapters



outlet can be rotated by 90°.

Converters and adapters expand the physical possibilities for connecting SIMATIC Operator Panels. This makes it possible, for example, to externally convert from RS422 to RS232. Furthermore, this allows SIMATIC S5 controllers and non-Siemens controllers to be connected. Using angled adapters, the connector

Industrial Hub 4

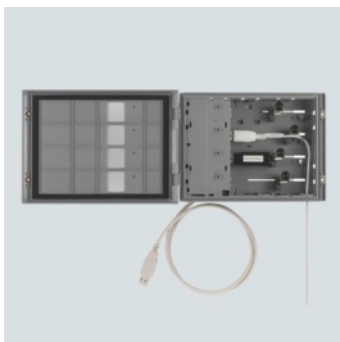

can also be optionally mounted direct on a standard mounting rail. All USB products approved for panels or PCs can be connected.

The active industrial USB Hub 4 has 4 USB V1.1 ports. These are arranged such that up to four standard USB flash drives, for example, can be securely attached. When installed, the four ports can be accessed simultaneously from the front via an IP65 flap and from the control cabinet at the back. The USB Hub 4

Protective covers, cover foils

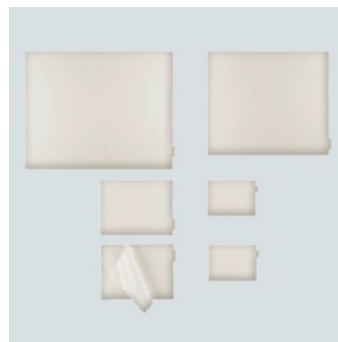

With protective covers, installed SIMATIC Operator Panels can be protected against scratching and dirt on the front side. The degree of protection of the panel is retained or even improved. In addition to protective covers, protective membranes are also available for the touch displays.

Connectors



power supply connectors can also be ordered.

For PROFIBUS and PROFINET, there is a comprehensive selection of connection plugs and plug-in connectors with various connection methods available. The bus connector is available in several versions for various cable outlets. Integrated terminating resistors can easily be connected from outside. 24 V DC

Service packs

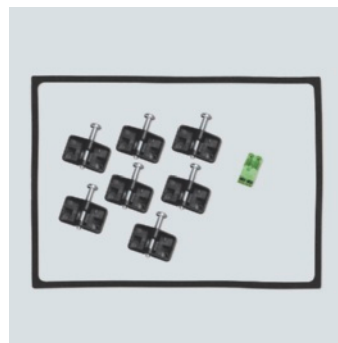

purpose.

Service packs for SIMATIC Panels contain all of the removable parts for the respective panel, e.g. mounting clamp, mounting seal, and connecting plug. The contents vary depending on the panel. You can easily create your own labeling strips using an inkjet or laser printer. A Word template is provided for this

SIMATIC Operator Panels at an introductory price

SIMATIC Panels starter packages

Easy entry at a minimum price: you save up to 40 % compared to purchasing the products individually.

Starter packages				
Consisting of	Panel	Engineering software	Cable	Other
Micro Panels				
OP 73micro	Operator Panel OP 73micro 3", Key	WinCC flexible Micro	MPI (5 m)	–
TP 177micro	Touch Panel TP 177micro 6"	WinCC flexible Micro	MPI (5 m)	–
Mobile Panels				
177 (DP Plus/PN Plus)	Mobile Panel 177 DP or PN 6", Touch + Key	WinCC flexible Compact	DP or PN (10 m)	Wall bracket, DP Box or PN Plus Box
277 (DP Plus/PN Plus)	Mobile Panel 277 8", Touch + Key	WinCC flexible Standard	DP or PN (10 m)	Wall bracket, PN Plus Box
277 IWLAN	Mobile Panel 277 IWLAN 8", Touch + Key	WinCC flexible Standard	–	1 x charging station, 1 x additional battery
277F IWLAN	Mobile Panel 277F IWLAN 8", Touch + Key	WinCC flexible Standard	–	3 x transponders, 1 x charging station, 1 x additional battery
Basic Panels				
KTP400 Basic mono PN	KTP400 Basic mono PN	WinCC flexible Compact	PN (10 m)	–
KTP600 Basic mono PN	KTP600 Basic mono PN	WinCC flexible Compact	PN (10 m)	–
KTP600 Basic color DP	KTP600 Basic color DP	WinCC flexible Compact	MPI (5 m)	–
KTP600 Basic color PN	KTP600 Basic color PN	WinCC flexible Compact	PN (10 m)	–
KTP1000 Basic color DP	KTP1000 Basic color DP	WinCC flexible Compact	MPI (5 m)	–
KTP1000 Basic color PN	KTP1000 Basic color PN	WinCC flexible Compact	PN (10 m)	–
TP1500 Basic color PN	TP1500 Basic color PN	WinCC flexible Compact	PN (10 m)	–
Panels				
OP 73	OP 73 Operator Panel 3", Key	WinCC flexible Compact	MPI (5 m), PC/PPI Multimaster	–
OP 77A	OP 77A Operator Panel 4.5", Key	WinCC flexible Compact	MPI (5 m), PC/PPI Multimaster	–
OP 77B	OP 77B Operator Panel 4.5", Key	WinCC flexible Compact	MPI (5 m), RS 232 (5 m)	–
TP 177A	TP 177A Touch Panel 6", Touch	WinCC flexible Compact	MPI (5 m), PC/PPI Multimaster	–
TP 177B 4"	TP 177B Touch Panel 4.3", TFT widescreen color display	WinCC flexible Compact	MPI (5 m), PC/PPI Multimaster	–
TP 177B 6"	TP 177B PN/DP Touch Panel 6", Touch	WinCC flexible Compact	MPI (5 m)	–
OP 177B	OP 177B PN/DP Operator Panel 6", Touch + Key	WinCC flexible Compact	MPI (5 m), PC/PPI Multimaster	–
Multi Panels				
MP 277 8", Touch	MP 277 Multi Panel 8", Touch	WinCC flexible Standard	MPI (5 m), PC/PPI (RS 232)	–
MP 277 10", Touch	MP 277 Multi Panel 10", Touch	WinCC flexible Standard	MPI (5 m), PC/PPI (RS 232)	–
MP 377 12", Touch	Multi Panel 12", Touch	WinCC flexible Standard	MPI (5 m)	–
MP 377 15", Touch	Multi Panel 15", Touch	WinCC flexible Standard	MPI (5 m)	–

The documentation is supplied on CD-ROM. For most of the devices, we offer a free one-year Software Update Service.

The new SIMATIC HMI promotion packages

SIMATIC TD 400C/SIMATIC S7-200 promotion package

The TD 400C provides a backlit, 4-line LC display and 15 freely assignable keys with tactile, acoustic or visual feedback. Additional user friendliness is made possible by the freely configurable interface of the device, which can be individually adapted to the respective application.

The TD 400C is ideally adapted to the performance and applications of the S7-200, which means lower configuration overhead. It is connected to the S7-200 using a standard MPI cable and configured with the SIMATIC STEP7 Micro/WIN software.

Components:

- TD 400C
- SIMATIC S7-200 CPU 224
- SIMATIC STEP7 Micro/Win V4.0
- Simulator module
- Memory module
- PPI cable
- HMI Manual Collection
- TANOS Box



SIMATIC KTP600 Basic color DP/SIMATIC S7-200 promotion package

The SIMATIC KTP600 Basic color DP has 6 keys with tactile feedback and a 6" touch display for intuitive operation. Communication is implemented over PROFIBUS by default. The new Basic Panel is configured with SIMATIC WinCC flexible.

The compact and powerful S7-200 micro PLC is the ideal controller for Basic Panels and is now available in a combined promotion package with the KTP600 Basic Panel.

Components:

- KTP600 Basic color DP
- SIMATIC S7-200 CPU 224
- SIMATIC WinCC flexible 2008 Compact
- SIMATIC STEP7 Micro/WIN 4.0 software
- PPI cable
- PROFIBUS cable
- HMI Manual Collection
- TANOS Box



SIMATIC MP 277/SIMATIC Thin Client promotion package

Thanks to the Windows CE operating system, the Multi Panel 277 offers PC-like openness and flexibility combined with rugged, compact, and cost-optimized hardware.

In large systems, where the same process must be controlled at several locations, the SIMATIC Thin Client can be used as a cost-effective, additional operator terminal.

In combination with the Multi Panel 277, all of the operating screens that are configured with SIMATIC WinCC flexible are not only displayed on the Multi Panel, but also via the WinCC flexible option Sm@rt Access on the Thin Client, where they can also be operated.

This means that the operator has on-site access to panel functionality on the Thin Client at a favorable price, which contributes to an improved overview, operability and thus productivity of the plant.

Components:

- SIMATIC Multi Panel 277 10" Touch
- SIMATIC Thin Client 10"
- SIMATIC WinCC flexible Standard
- SIMATIC WinCC flexible Sm@rt Access license
- MPI cable
- PROFINET cables
- HMI Manual Collection



Take advantage of the new promotion packages to become familiar with the benefits of the perfect interplay of the selected combinations of devices. The packages are only available for a limited time. For further information, see:

www.siemens.com/simatic-hmi

Get more information

www.siemens.com/simatic-hmi

www.siemens.com/simatic-panels

SIPLUS extreme – hardening and finishing:

www.siemens.com/siplus-extreme

SIMATIC Guide manuals:

www.siemens.com/simatic-docu

You can order further documents on the topic SIMATIC at:

www.siemens.com/simatic/printmaterial

Service & Support Portal:

www.siemens.com/automation/support

SIMATIC contacts:

www.siemens.com/automation/partner

Information and ordering platform:

www.siemens.com/industrymall

Siemens AG
Industry Sector
Industrial Automation Systems
Postfach 48 48
90327 NÜRNBERG
GERMANY

www.siemens.com/automation

Subject to change without prior notice
PDF (6ZB5370-0CJ02-0BB2)
3P.8101.30.08 / Dispo 26100
BR 0409 3.0 ROT 28+16 En
0410 5. PDF / 3P.8201.30.09
Printed in Germany
© Siemens AG 2009

Die Informationen in dieser Broschüre enthalten Beschreibungen bzw. Leistungsmerkmale, welche im konkreten Anwendungsfall nicht immer in der beschriebenen Form zutreffen bzw. welche sich durch Weiterentwicklung der Produkte ändern können. Die gewünschten Leistungsmerkmale sind nur dann verbindlich, wenn sie bei Vertragsschluss ausdrücklich vereinbart werden. Liefermöglichkeiten und technische Änderungen vorbehalten. Alle Erzeugnisbezeichnungen können Marken oder Erzeugnisnamen der Siemens AG oder anderer, zuliefernder Unternehmen sein, deren Benutzung durch Dritte für deren Zwecke die Rechte der Inhaber verletzen kann.

SIMATIC Panels

Operator panels to suit all demands

Technical specifications · April 2009



SIMATIC HMI

Answers for industry.

SIEMENS

Technology overview

	Basic Panels							Panels										Multi Panels										Mobile Panels				
	Low-cost operator control and monitoring of simple applications							70 series			170 series				270 series			170 series		270 series				370 series				Maximum mobility for operator control and monitoring				
	4" Touch + Key	6" Touch + Key	6" Touch + Key	6" Touch + Key	10" Touch + Key	10" Touch + Key	15" Touch	3" Key	4.5" Key	4.5" Key	6" Touch	4" Touch	6" Touch	6" Touch + Key	6" Touch	6" Key	6" Touch	8" Touch	10" Touch	8" Key	10" Key	12" Touch	12" Key	15" Touch	19" Touch	6" Touch + Key	8" Touch + Key	8" Touch + Key	10" Touch			
Display	STN liquid crystal display (LCD), 4 gray scales	STN liquid crystal display (LCD), 4 gray scales	TFT liquid crystal display (LCD), 256 colors	TFT liquid crystal display (LCD), 256 colors	TFT liquid crystal display (LCD), 256 colors	TFT liquid crystal display (LCD), 256 colors	TFT liquid crystal display (LCD), mono-chrome	STN liquid crystal display (LCD), mono-chrome	STN liquid crystal display (LCD), mono-chrome	STN liquid crystal display (LCD), mono-chrome	STN liquid crystal display (LCD), 4 blue levels	TFT wide-screen display (LCD), 256 colors	STN liquid crystal display (LCD), 4 blue levels or 256 colors	STN liquid crystal display (LCD), 4 blue levels or 256 colors	TFT liquid crystal display (LCD), 256 colors	TFT liquid crystal display (LCD), 256 colors	TFT liquid crystal display (LCD), 64K colors	TFT liquid crystal display (LCD), 64K colors	TFT liquid crystal display (LCD), 64K colors	TFT liquid crystal display (LCD), 64K colors	TFT liquid crystal display (LCD), 64K colors	TFT liquid crystal display (LCD), 64K colors	TFT liquid crystal display (LCD), 64K colors	TFT liquid crystal display (LCD), 64K colors	TFT liquid crystal display (LCD), 64K colors	STN liquid crystal display (LCD), 256 colors	TFT liquid crystal display (LCD), 64K colors	TFT liquid crystal display (LCD), 64K colors	TFT liquid crystal display (LCD), 64K colors	TFT liquid crystal display (LCD), 64K colors		
Size (in inches)	3.8	5.7	5.7	5.7	10.4	10.4	3	4.5	4.5	5.7	4.3	5.7	5.7	5.7	5.7	5.7	7.5	10.4	7.5	10.4	12.1	12.1	15	19	5.7	7.5	7.5	10.4	10.4			
Resolution (W x H in pixels)	320 x 240	320 x 240	320 x 240	320 x 240	640 x 480	640 x 480	160 x 48	160 x 64	160 x 64	320 x 240	480 x 272	320 x 240	320 x 240	320 x 240	320 x 240	320 x 240	320 x 240	640 x 480	640 x 480	640 x 480	640 x 480	800 x 600	800 x 600	1024 x 768	1280 x 1024	320 x 240	640 x 480	640 x 480	800 x 600	800 x 600		
MTBF backgr. lighting (at 25°C in h)	30,000	50,000	50,000	50,000	50,000	50,000	100,000	100,000	100,000	50,000	30,000	50,000	50,000	50,000	50,000	50,000	50,000	50,000	50,000	50,000	50,000	50,000	50,000	50,000	50,000	50,000	50,000	50,000	50,000	50,000		
Front dimensions (in mm)	140 x 116	214 x 158	214 x 158	214 x 158	335 x 275	335 x 275	140 x 116	150 x 186	150 x 186	212 x 156	140 x 116	212 x 156	243 x 212.5	212 x 156	308 x 204	212 x 156	212 x 156	240 x 180	325 x 263	352 x 221	483 x 310	335 x 275	483 x 310	400 x 310	483 x 400	Diameter 245	Diameter 290	Diameter 290	Diameter 350	Diameter 350		
Operator controls	Touch screen, 4 tactile keys	Touch screen, 6 tactile keys	Touch screen, 6 tactile keys	Touch screen, 6 tactile keys	Touch screen, 8 tactile keys	Touch screen, 8 tactile keys	Membrane keyboard	Membrane keyboard	Membrane keyboard	Touch screen	Membrane keyboard, touch screen	Touch screen	Membrane keyboard, touch screen	Touch screen	Membrane keyboard	Touchscreen	Touchscreen	Touchscreen	Membrane keyboard	Membrane keyboard	Touchscreen	Membrane keyboard	Membrane keyboard	Touchscreen	Touchscreen	Membrane keyboard, touch screen	Membrane keyboard, touch screen	Membrane keyboard, touch screen	Touch screen	Touch screen		
Function keys (programmable)/ system keys	4 / -	6 / -	6 / -	6 / -	8 / -	8 / -	4 / 8	8 / 23	8 / 23	- / -	4 / -	- / -	32 / -	- / -	24 / 36	- / -	- / -	- / -	26 / 38	36 / 38	- / -	36 / 38	36 / 38	- / -	14 / 14	18 / 18	18 / 18	18 / 18	- / -	- / -		
External keyboard/mouse/printer	- / - / -	- / - / -	- / - / -	- / - / -	- / - / -	- / - / -	- / - / -	- / - / -	- / - / -	- / - / -	USB / USB / USB	USB / USB / USB	USB / USB / USB	USB / USB / USB	USB / USB / USB	USB / USB / USB	USB / USB / USB	USB / USB / USB	USB / USB / USB	USB / USB / USB	USB / USB / USB	USB / USB / USB	USB / USB / USB	USB / USB / USB	USB / USB / USB	- / - / -	USB / USB / USB	USB / USB / USB	USB / USB / USB	USB / USB / USB		
Usable memory	512 Kbyte	512 Kbyte	512 Kbyte	512 Kbyte	1024 Kbyte	1024 Kbyte	256 Kbyte	256 Kbyte	1024 Kbyte	512 Kbyte	2 Mbyte	2 Mbyte	2 Mbyte	4 Mbyte	4 Mbyte	2 Mbyte	6 Mbyte	6 Mbyte	6 Mbyte	6 Mbyte	6 Mbyte	12 Mbyte	12 Mbyte	12 Mbyte	12 Mbyte	2 Mbyte	6 Mbyte	6 Mbyte	6 Mbyte	6 Mbyte		
Memory for options/recipes ¹⁾	- / 40 Kbyte	- / 40 Kbyte	- / 40 Kbyte	- / 40 Kbyte	- / 40 Kbyte	- / 40 Kbyte	- / -	- / 32 Kbyte	- / 32 Kbyte	- / 32 Kbyte	- / 32 Kbyte	- / 32 Kbyte	- / 64 Kbyte	- / 64 Kbyte	- / 64 Kbyte	- / 32 Kbyte	1024 Kbyte / 64 Kbyte	1024 Kbyte / 64 Kbyte	1024 Kbyte / 64 Kbyte	1024 Kbyte / 64 Kbyte	1024 Kbyte / 64 Kbyte	12 Mbyte / 128 Kbyte	12 Mbyte / 128 Kbyte	12 Mbyte / 128 Kbyte	12 Mbyte / 12 Kbyte	- / 32 Kbyte	1024 Kbyte / 64 Kbyte	1024 Kbyte / 64 Kbyte	1024 Kbyte / 64 Kbyte	1024 Kbyte / 64 Kbyte		
Alarm buffer	*	*	*	*	*	*	*	*	*	*	*	*	*	*	*	*	*	*	*	*	*	*	*	*	*	*	*	*	*	*	*	
Interfaces																																
Serial / MPI / PROFIBUS DP	- / - / -	- / - / -	- / * / *	- / - / -	- / * / *	- / - / -	- / * / *	- / * / *	- / * / *	- / * / *	* ²⁾ / * / *	* ²⁾ / * / *	* ²⁾ / * / *	* ²⁾ / * / *	* ²⁾ / * / *	* ²⁾ / * / *	* ²⁾ / * / *	* ²⁾ / * / *	* ²⁾ / * / *	* ²⁾ / * / *	* ²⁾ / * / *	* ²⁾ / * / *	* ²⁾ / * / *	* ²⁾ / * / *	* ²⁾ / * / *	* ²⁾ / * / *	* ²⁾ / * / *	* ²⁾ / * / *	* ²⁾ / * / *	* ²⁾ / * / *		
PROFINET (Ethernet)	*	*	*	*	*	*	*	*	*	*	*	*	*	*	*	*	*	*	*	*	*	*	*	*	*	*	*	*	*	*	*	
USB	-	-	-	-	-	-	-	-	-	-	-	-	-	-	-	-	-	-	-	-	-	-	-	-	-	-	-	-	-	-	-	
Slot for CF / Multi Media / SD Cards	- / - / -	- / - / -	- / - / -	- / - / -	- / - / -	- / - / -	- / - / -	- / - / -	- / - / -	- / - / -	- / * / *	- / * / *	- / * / *	- / * / *	- / * / *	- / * / *	- / * / *	- / * / *	- / * / *	- / * / *	- / * / *	- / * / *	- / * / *	- / * / *	- / * / *	- / * / *	- / * / *	- / * / *	- / * / *	- / * / *	- / * / *	- / * / *
Functionality (when configuring with WinCC flexible)																																
Signaling system (number of messages/message classes)	200 / 32	200 / 32	200 / 32	200 / 32	200 / 32	200 / 32	500 / 32	1000 / 32	1000 / 32	1000 / 32	2000 / 32	2000 / 32	2000 / 32	4000 / 32	4000 / 32	2000 / 32	4000 / 32	4000 / 32	4000 / 32	4000 / 32	4000 / 32	4000 / 32	4000 / 32	4000 / 32	4000 / 32	2000 / 32	4000 / 32	4000 / 32	4000 / 32	4000 / 32	4000 / 32	
Process screens	50	50	50	50	50	50	500	500	500	250	500	500	500	500	500	500	500	500	500	500	500	500	500	500	500	500	500	500	500	500	500	
Tags	250	500	500	500	500	500	1000	1000	1000	500	1000	1000	1000	2048	2048	1000	2048	2048	2048	2048	2048	4096 ⁷⁾	4096 ⁷⁾	4096 ⁷⁾	4096 ⁷⁾	1000	2048	2048	2048	2048	2048	
Vector graphics	*	*	*	*	*	*	-	-	-	*	*	*	*	*	*	*	*	*	*	*	*	*	*	*	*	*	*	*	*	*	*	
Bar graphs/curve charts	* / *	* / *	* / *	* / *	* / *	* / *	* / -	* / -	* / -	* / *	* / *	* / *	* / *	* / *	* / *	* / *	* / *	* / *	* / *	* / *	* / *	* / *	* / *	* / *	* / *	* / *	* / *	* / *	* / *	* / *	* / *	
Faceplates	-	-	-	-	-	-	-	-	-	-	-	-	-	-	-	-	-	-	-	-	-	-	-	-	-	-	-	-	-	-	-	
Recipes	5	5	5	5	5	5	-	5	100	5	100	100	100	300	300	100	300	300	300	300	300	500	500	500	500	100	300	300	300	300		
Archiving	-	-	-	-	-	-	-	-	-	-	-	-	-	-	-	-	-	-	-	-	-	-	-	-	-	-	-	-	-	-	-	
Visual Basic scripts	-	-	-	-	-	-	-	-	-	-	-	-	-	-	-	-	-	-	-	-	-	-	-	-	-	-	-	-	-	-	-	
PG functions (STATUS/CONTROL)	-	-	-	-	-	-	-	-	-	-	-	-	-	-	-	-	-	-	-	-	-	-	-	-	-	-	-	-	-	-	-	
Connection to controller																																
SIMATIC S7 / SIMATIC WinAC	* / *	* / *	* / *	* / *	* / *	* / *	* / *	* / *	* / *	* / *	* / *	* / *	* / *	* / *	* / *	* / *	* / *	* / *	* / *	* / *	* / *	* / *	* / *	* / *	* / *	* / *	* / *	* / *	* / *	* / *	* / *	* / *
SIMATIC S5 / SIMATIC S05	- / -	- / -	- / -	- / -	- / -	- / -	- / -	- / -	- / -	- / -	- / -	- / -	- / -	- / -	- / -	- / -	- / -	- / -	- / -	- / -	- / -	- / -	- / -	- / -	- / -	- / -	- / -	- / -	- / -	- / -	- / -	- / -
SINUMERIK / SIMOTION	- / -	- / -	- / -	- / -	- / -	- / -	- / -	- / -	- / -	- / -	- / -	- / -	- / -	- / -	- / -	- / -	- / -	- / -	- / -	- / -	- / -	- / -	- / -	- / -	- / -	- / -	- / -	- / -	- / -	- / -	- / -	- / -
Allen Bradley / Mitsubishi	- / -	- / -	* / *	* / *	* / *	* / *	- / -	- / -	- / -	- / -	- / -	- / -	- / -	- / -	- / -	- / -	- / -	- / -	- / -	- / -	- / -	- / -	- / -	- / -	- / -	- / -	- / -	- / -	- / -	- / -	- / -	- / -
Modicon/Omron/GE-Fanuc/LG/Glofa/GM	* / - / - / -	* / - / - / -	* / - / - / -	* / - / - / -	* / - / - / -	* / - / - / -	- / -	- / -	- / -	- / -	- / -	- / -	- / -	- / -	- / -	- / -	- / -	- / -	- / -	- / -	- / -	- / -	- / -	- / -	- / -	- / -	- / -	- / -	- / -	- / -	- / -	- / -
Engineering software	STEP 7 Basic ⁹⁾	STEP 7 Basic ⁹⁾	STEP 7 Basic ⁹⁾	STEP 7 Basic ⁹⁾	STEP 7 Basic ⁹⁾	STEP 7 Basic ⁹⁾	WinCC flexible Compact, Standard, Advanced	WinCC flexible Compact, Standard, Advanced	WinCC flexible Compact, Standard, Advanced	WinCC flexible Compact, Standard, Advanced	WinCC flexible Compact, Standard, Advanced	WinCC flexible Compact, Standard, Advanced	WinCC flexible Compact, Standard, Advanced	WinCC flexible Compact, Standard, Advanced	WinCC flexible Compact, Standard, Advanced	WinCC flexible Compact, Standard, Advanced	WinCC flexible Compact, Standard, Advanced	WinCC flexible Compact, Standard, Advanced	WinCC flexible Compact, Standard, Advanced	WinCC flexible Compact, Standard, Advanced	WinCC flexible Compact, Standard, Advanced	WinCC flexible Compact, Standard, Advanced	WinCC flexible Compact, Standard, Advanced	WinCC flexible Compact, Standard, Advanced	WinCC flexible Compact, Standard, Advanced	WinCC flexible Compact, Standard, Advanced	WinCC flexible Compact, Standard, Advanced	WinCC flexible Compact, Standard, Advanced	WinCC flexible Compact, Standard, Advanced	WinCC flexible Compact, Standard, Advanced	WinCC flexible Compact, Standard, Advanced	
Options, applications																																
Sm@rtService / Sm@rtAccess / ProAgent / Audit / Logon	- / - / - / -	- / - / - / -	- / - / - / -	- / - / - / -	- / - / - / -	- / - / - / -	- / - / - / -	- / - / - / -	- / - / - / -	- / - / - / -	- / - / - / -	- / - / - / -	- / - / - / -	- / - / - / -	- / - / - / -	- / - / - / -	- / - / - / -	- / - / - / -	- / - / - / -	- / - / - / -	- / - / - / -	- / - / - / -	- / - / - / -	- / - / - / -	- / - / - / -	- / - / - / -	- / - / - / -	- / - / - / -	- / - / - / -	- / - / - / -	- / - / - / -	- / - / - / -
OPC server / Pocket Internet Explorer	- / -	- / -	- / -	- / -	- / -	- / -	- / -	- / -	- / -	- / -	- / -	- / -	- / -	- / -	- / -	- / -	- / -	- / -	- / -	- / -	- / -	- / -	- / -	- / -	- / -	- / -	- / -	- / -	- / -	- / -	- / -	- / -
WinAC MP	-	-	-	-	-	-	-	-	-	-	-	-	-	-	-	-	-	-	-	-	-	-	-	-	-	-	-	-	-	-	-	-

¹⁾ Device version PN ²⁾ Device version DP ³⁾ PN/DP version ⁴⁾ RS232 with adapter ⁵⁾ Using PROFIBUS DP only ⁶⁾ Integrated flash, expandable using memory card ⁷⁾ Configuration with WinCC flexible 2008 or higher ⁸⁾ Only monitoring mode for Mobile Panel 277E IWLAN ⁹⁾ With integrated WinCC Basic for S7-1200

Technology Overview

Push Button Panels

The innovative operator panels

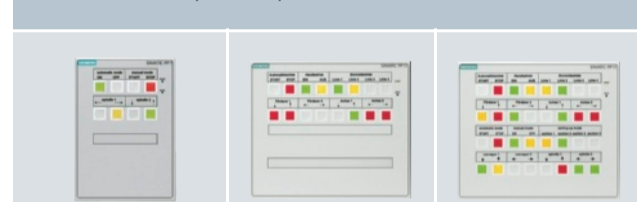

	PP7	PP17-I	PP17-II
Type of operation			
Function keys (programmable)	8 with LEDs	16 with LEDs	16 with LEDs
Output type			
LED color modes	3	3	3
Number of LEDs	8	16	32
Typical service life			
Short-stroke keys (switching cycles)	1,500,000	1,500,000	1,500,000
LEDs (ON period in %)		100	
Digital inputs			
Number of digital inputs	4	16	16
Digital outputs			
Number of digital outputs	–	16	16
Functionality			
Key and lamp test	yes	yes	yes
Degree of protection			
Front / rear	IP65/IP20	IP65/IP20	IP65/IP20
Connection to controller			
SIMATIC S7, WinAC	MPI, PROFIBUS DP	MPI, PROFIBUS DP	MPI, PROFIBUS DP
SIMATIC S5	PROFIBUS DP	PROFIBUS DP	PROFIBUS DP
Masters of any vendor	PROFIBUS DP	PROFIBUS DP	PROFIBUS DP
Ambient conditions			
Mounting position	Vertical	Vertical	Vertical
Max. permissible angle of inclination without forced ventilation (in degrees)	+/- 35	+/- 35	+/- 35
Max. relative humidity (in %)	95	95	95
Temperature			
Operation (vertical installation in °C)	0 ... + 55	0 ... + 55	0 ... + 55
Operation (max. angle of inclination in °C)	0 ... + 55	0 ... + 55	0 ... + 55
Dimensions			
Enclosure front (W x H in mm)	114 x 204	114 x 204	114 x 204
Installation cutout/device depth (W x H / D in mm)	130 x 190 / 53	130 x 190 / 53	130 x 190 / 53

Micro Panels

Simple and low-cost operator control with the SIMATIC S7-200



	TD 100C	TD 200I/TD 200C	TD 400C	OP 73micro	TP 177micro
Key	Key	Key	Key	3" Key	6" Touch
Display	STN display (reflecting-no backlighting)	STN display (with backlighting)	STN display (with backlighting)	STN liquid crystal display (LCD), monochrome	STN liquid crystal display (LCD) 4 blue levels
Size (in inches)	4 lines	2 lines	4 lines	3"	5.7"
Resolution (W x H in pixels)	Max. 16 characters/line Character height 3.34 mm	Max. 20 characters/line Character height 3 mm	16 or 24 characters/line	160 x 48	320 x 240
MTBF backgr. lighting (at 25 °C in h)	–	50,000	50,000	100,000	50,000
Front dimensions (in mm)	90 x 76	148 x 76	174 x 102	154 x 84	212 x 156
Operator controls	Membrane keyboard	Membrane keyboard	Membrane keyboard	Membrane keyboard	Touch screen
Function keys (programmable)/system keys	14 (freely configurable)	TD 200: 8 / 5; TD 200C: 20 (freely configurable)	15 (freely configurable)	4 / 8	– / –
External keyboard/mouse/printer	– / – / –	– / – / –	– / – / –	– / – / –	– / – / –
Memory					
User memory	User data on CPU	User data on CPU	User data on CPU	128 Kbyte	256 Kbyte
Memory for options/recipes ⁶⁾	– / –	– / –	– / –	– / –	– / –
Alarm buffer	–	–	–	•	•
Interfaces					
Serial / MPI / PROFIBUS DP	PPI	PPI	PPI	PPI	PPI
PROFINET (Ethernet)	–	–	–	–	–
USB	–	–	–	–	–
Slot for CF / Multi Media / SD Cards	– / – / –	– / – / –	– / – / –	– / – / –	– / – / –
Functionality (when configuring with WinCC flexible)	Configuration by means of MicroWIN	Configuration by means of MicroWIN	Configuration by means of MicroWIN		
Signaling system (number of messages/message classes)	40	80	80	250 / 32	500 / 32
Process screens	32	64	64	250	250
Tags	288	864	864	500	250
Vector graphics	–	–	–	–	•
Bar graphs/curve charts	– / –	– / –	– / –	• / –	• / •
Faceplates	–	–	–	–	–
Recipes	–	–	–	–	–
Archiving	–	–	–	–	–
Visual Basic scripts	–	–	–	–	–
PG functions (STATUS/CONTROL)	–	–	–	–	–
Connection to controller					
SIMATIC S7 / SIMATIC WinAC	S7-200	S7-200	S7-200	S7-200	S7-200
SIMATIC S5 / SIMATIC S05	–	–	–	–	–
SINUMERIK / SIMOTION	–	–	–	–	–
Allen Bradley / Mitsubishi	–	–	–	–	–
Modicon / Omron / GE-Fanuc / LG Glofa GM	–	–	–	–	–
Engineering software	MicroWIN V4.0 SP2	MicroWIN V4.0	MicroWIN V4.0 SP 6	WinCC flexible Micro, Compact, Standard, Advanced	
Options, application					
Sm@rtService / Sm@rtAccess / ProAgent / Audit / Logon	–	–	–	–	–
OPC server / Pocket Internet Explorer	–	–	–	– / –	– / –
WinAC MP	–	–	–	–	–

Thin Clients

Low-cost operator stations in distributed systems

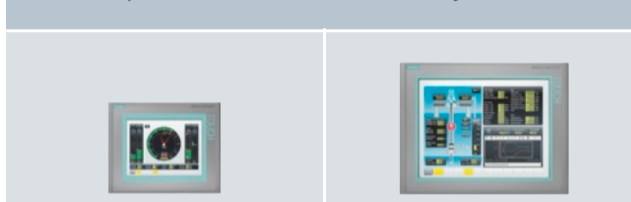

	Thin Client 10" Touch	Thin Client 15" Touch
Thin Client	TFI, 64K colors	TFI, 64K colors
Resolution	325 x 263	400 x 310
Number of LEDs	–	–
Touchscreen	– / –	– / –
External keyboard/mouse/printer	– / via USB / –	– / via USB / –
Memory	–	–
User memory	–	–
Memory for options/recipes ⁶⁾	–	–
Alarm buffer	–	–
Interfaces		
Serial / MPI / PROFIBUS DP	–	–
PROFINET (Ethernet)	–	–
USB	–	–
Slot for CF / Multi Media / SD Cards	–	–
Functionality (when configuring with WinCC flexible)		
Signaling system (number of messages/message classes)	–	–
Process screens	–	–
Tags	–	–
Vector graphics	–	–
Bar graphs/curve charts	–	–
Faceplates	–	–
Recipes	–	–
Archiving	–	–
Visual Basic scripts	–	–
PG functions (STATUS/CONTROL)	–	–
Connection to controller		
SIMATIC S7 / SIMATIC WinAC	S7-200	S7-200
SIMATIC S5 / SIMATIC S05	–	–
SINUMERIK / SIMOTION	–	–
Allen Bradley / Mitsubishi	–	–
Modicon / Omron / GE-Fanuc / LG Glofa GM	–	–
Engineering software	MicroWIN V4.0 SP2	MicroWIN V4.0
Options, application		
Sm@rtService / Sm@rtAccess / ProAgent / Audit / Logon	–	–
OPC server / Pocket Internet Explorer	–	–
WinAC MP	–	–

Operator panels for special requirements

Fully protected HMI devices

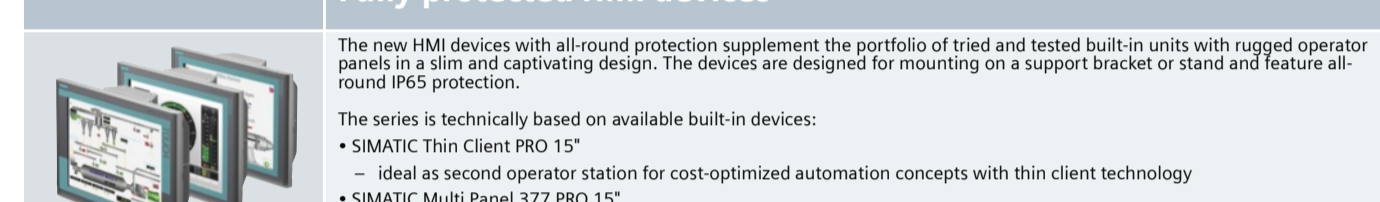

	Thin Client 10" Touch	Thin Client 15" Touch
Thin Client	TFI, 64K colors	TFI, 64K colors
Resolution	325 x 263	400 x 310
Number of LEDs	–	–
Touchscreen	– / –	– / –
External keyboard/mouse/printer	– / via USB / –	– / via USB / –
Memory	–	–
User memory	–	–
Memory for options/recipes ⁶⁾	–	–
Alarm buffer	–	–
Interfaces		
Serial / MPI / PROFIBUS DP	–	–
PROFINET (Ethernet)	–	–
USB	–	–
Slot for CF / Multi Media / SD Cards	–	–
Functionality (when configuring with WinCC flexible)		
Signaling system (number of messages/message classes)	–	–
Process screens	–	–
Tags	–	–
Vector graphics	–	–
Bar graphs/curve charts	–	–
Faceplates	–	–
Recipes	–	–
Archiving	–	–
Visual Basic scripts	–	–
PG functions (STATUS/CONTROL)	–	–
Connection to controller		
SIMATIC S7 / SIMATIC WinAC	S7-200	S7-200
SIMATIC S5 / SIMATIC S05	–	–
SINUMERIK / SIMOTION	–	–
Allen Bradley / Mitsubishi	–	–
Modicon / Omron / GE-Fanuc / LG Glofa GM	–	–
Engineering software	MicroWIN V4.0 SP2	MicroWIN V4.0
Options, application		
Sm@rtService / Sm@rtAccess / ProAgent / Audit / Logon	–	–
OPC server / Pocket Internet Explorer	–	–
WinAC MP	–	–

Accessories

Memory media

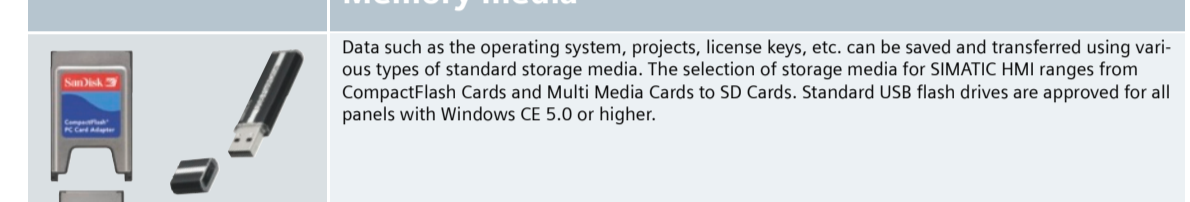

	Thin Client 10" Touch	Thin Client 15" Touch
Thin Client	TFI, 64K colors	TFI, 64K colors
Resolution	325 x 263	400 x 310
Number of LEDs	–	–
Touchscreen	– / –	– / –
External keyboard/mouse/printer	– / via USB / –	– / via USB / –
Memory	–	–
User memory	–	–
Memory for options/recipes ⁶⁾	–	–
Alarm buffer	–	–
Interfaces		
Serial / MPI / PROFIBUS DP	–	–
PROFINET (Ethernet)	–	–
USB	–	–
Slot for CF / Multi Media / SD Cards	–	–
Functionality (when configuring with WinCC flexible)		
Signaling system (number of messages/message classes)	–	–
Process screens	–	–
Tags	–	–
Vector graphics	–	–
Bar graphs/curve charts	–	–
Faceplates	–	–
Recipes	–	–
Archiving	–	–
Visual Basic scripts	–	–
PG functions (STATUS/CONTROL)	–	–
Connection to controller		
SIMATIC S7 / SIMATIC WinAC	S7-200	S7-200
SIMATIC S5 / SIMATIC S05	–	–
SINUMERIK / SIMOTION	–	–
Allen Bradley / Mitsubishi	–	–
Modicon / Omron / GE-Fanuc / LG Glofa GM	–	–
Engineering software	MicroWIN V4.0 SP2	MicroWIN V4.0
Options, application		
Sm@rtService / Sm@rtAccess / ProAgent / Audit / Logon	–	–
OPC server / Pocket Internet Explorer	–	–
WinAC MP	–	–

Data such as the operating system, projects, license keys, etc. can be saved and transferred using various types of standard storage media. The selection of storage media for SIMATIC HMI ranges from CompactFlash Cards and Multi-Media Cards to SD Cards. Standard USB flash drives are approved for all panels with Windows CE 5.0 or higher.

Industrial Hub 4

The active industrial USB Hub 4 has four USB V1.1 ports. These are arranged such that up to four standard USB flash drives can be locked in securely. When installed, the four ports can be accessed from the control cabinet via an IP65 flap on the front and back. The USB Hub 4 can also be optionally mounted directly on a standard mounting rail. All USB products approved for panels or PCs can be connected.

Connectors

For PROFIBUS and PROFINET, there is a comprehensive range of connection plugs and plug-in connectors with various connection methods available. The bus connector is available in several versions for various cable outlets. Integrated terminating resistors can easily be connected from the outside. 24 V DC power supply connectors can also be ordered.

Converters/adapters

Converters and adapters expand the physical possibilities for connecting SIMATIC Operator Panels. This makes it possible, for example, to externally convert from RS422 to RS232. Furthermore, this allows SIMATIC S5 controllers and third-party controllers to be connected. Using angled adapters, the connector outlet can be rotated by 90°.

Protective covers, cover foils

With protective covers, installed SIMATIC Operator Panels can be protected against scratching and dirt on the front side. The degree of protection of the panel is retained or even improved. In addition to protective covers, there are also cover foils for touch displays available.

Service packs

Service packs for SIMATIC Operator Panels contain all of the loose parts for the respective panel, e.g. mounting wrench, mounting seal, and connection plug. The contents vary depending on the panel. You can easily create your own labeling strips using an inkjet or laser printer. A Word template is provided for this purpose.

Get more information

www.siemens.com/simatic-hmi

www.siemens.com/simatic-panels

SIPLUS extreme – hardening and finishing:

www.siemens.com/siplus

For further details, refer to the SIMATIC Manuals Guide:

www.siemens.com/simatic-docu

You can order further documents on the topic SIMATIC at:

www.siemens.com/simatic/printmaterial

In-depth technical documentation is available from our Service&Support Portal:

www.siemens.com/automation/support

For a personal discussion, you can locate your nearest contact at:

www.siemens.com/automation/partner

You can place a direct order electronically over the Internet at the Industry Mall:

www.siemens.de/industrymall

Siemens AG
Industry Sector
Postfach 48 48
90026 NÜRNBERG
GERMANY

www.siemens.com/automation

Subject to change without prior notice
PDF (6ZB5370-0CJ02-0BB2)
3P.8101.30.09 / Dispo 26100
BR 0509 3. ROT 16 En
0410 5. PDF / 3P.8201.30.09
Printed in Germany
© Siemens AG 2009

The information provided in this brochure contains descriptions or characteristics of performance which in case of actual use do not always apply as described or which may change as a result of further development of the products. An obligation to provide the respective characteristics shall only exist if expressly agreed in the terms of contract. Availability and technical specifications are subject to change without notice.

All product designations may be trademarks or product names of Siemens AG or supplier companies whose use by third parties for their own purposes could violate the rights of the owners.